



BERNINA 485

LOOKING FOR A NEW SEWING PROJECT?

You can find what you want in "inspiration", our sewing magazine. Thanks to great sewing patterns and detailed sewing instructions, every project succeeds right away.

Inspiration magazine
is available in German, English,
French and Dutch



* Not available in all countries.

Edition notice

Graphics

www.sculpt.ch

Text, Setting and Layout

BERNINA International AG

Photos

Patrice Heilmann, Winterthur

Part number

2018/02 en 1031765.0.04

1st Edition

Copyright

2018 BERNINA International AG

All rights reserved: For technical reasons and for the purpose of product improvements, changes concerning the features of the machine can be made at any time and without advance notice. The supplied accessory can vary depending on the country of delivery.



Contents

IMPORTANT SAFETY INSTRUCTIONS.....	11
1 My BERNINA.....	15
1.1 Introduction.....	15
1.2 Welcome to the world of BERNINA.....	15
1.3 Key to signs.....	16
1.4 Overview Machine.....	17
Overview front controls.....	17
Overview front.....	18
Overview sideways.....	19
Overview back.....	20
1.5 Supplied accessories.....	21
Overview accessories machine.....	21
Use of the power cable (only USA/Canada).....	22
Overview presser feet.....	23
Accessory box.....	24
1.6 Overview User Interface.....	25
Overview functions/visual information.....	25
Overview System settings.....	25
Overview selection menu sewing.....	26
Overview Icons.....	26
1.7 Needle, Thread, Fabric.....	27
Overview needles.....	27
Example for needle description.....	29
Thread selection.....	29
Needle/thread combination.....	30
2 Sewing preparation.....	31
2.1 Accessory box.....	31
Removing and attaching the accessory box.....	31
Storing accessories.....	31
2.2 Connection and Switching on.....	32
Connecting the foot control.....	32
Connecting the machine.....	32
Attaching the knee lifter of the Free Hand System.....	32
Attaching the touchscreen pen (optional accessory).....	33
Switching the machine on.....	33
2.3 Foot control.....	33
Regulating the speed via the foot control.....	33
Raising/Lowering the needle.....	34
2.4 Spool pin.....	34
Retractable spool pin.....	34
Horizontal spool pin.....	35
2.5 Free arm.....	35
2.6 Feed dog.....	36
Adjusting the feed dog.....	36
Instruction for adjusting the feed dog.....	37



2.7	Slide-on table.....	37
	Using the slide-on table.....	37
2.8	Presser foot.....	37
	Adjusting the presser foot position via the knee lifter of the Free Hand System.....	37
	Changing the presser foot.....	37
	Having the presser foot displayed in the User Interface.....	38
	Adjusting the presser foot pressure.....	38
2.9	Needle and stitch plate.....	39
	Changing the needle.....	39
	Selecting the needle in the User Interface.....	40
	Selecting the needle type and the needle size.....	40
	Adjusting the needle position up/down.....	40
	Adjusting the needle position left/right.....	40
	Needle stop up/down (permanent).....	41
	Changing the stitch plate.....	41
	Selecting the stitch plate in the User Interface.....	42
2.10	Threading.....	42
	Threading the upper thread.....	42
	Threading the double needle.....	44
	Threading the triple needle.....	45
	Winding the bobbin thread.....	46
	Threading the bobbin thread.....	46
	Instruction how to thread the bobbin thread.....	48
3	Setup Program.....	49
3.1	Sewing settings.....	49
	Adjusting the upper thread tension.....	49
	Adjusting the maximum sewing speed.....	49
	Programming securing stitches.....	49
	Programming the button «Thread cutter».....	50
	Programming the button «Securing».....	50
	Programming the button «Quick reverse».....	51
	Programming the foot control.....	51
3.2	Selecting personal settings.....	52
3.3	Activating the audio signals.....	53
3.4	Machine settings.....	54
	Selecting a language.....	54
	Adjusting the brightness of the display.....	54
	Checking the firmware version.....	54
	Reviewing the total number of stitches.....	55
	Registering details of the dealer.....	55
	Saving Service data.....	56
	Back to default setting.....	56
	Deleting user data.....	57
	Calibrating the Buttonhole foot No. 3A.....	57
	Updating the machine Firmware.....	58
	Recovering saved data.....	59
	Cleaning the thread catcher.....	59
	Lubricating the machine.....	60



4	System settings.....	61
4.1	Calling up the Tutorial.....	61
4.2	Calling up the Creative Consultant.....	61
4.3	Using eco mode.....	61
4.4	Calling up the Help.....	61
4.5	Cancelling any alterations with «clr».....	62
5	Creative sewing.....	63
5.1	Overview selection menu sewing.....	63
	Selecting a stitch pattern.....	63
5.2	Regulating the speed.....	63
5.3	Adjusting the upper thread tension.....	63
5.4	Editing stitch patterns.....	64
	Changing the stitch width.....	64
	Changing the stitch length.....	64
	Correcting the balance.....	65
	Programming pattern repeat.....	65
	Mirror image of stitch patterns.....	65
	Quick reverse.....	66
	Permanent Quick reverse.....	66
5.5	Combining stitch patterns.....	66
	Overview Combi mode.....	66
	Creating Stitch pattern combinations.....	67
	Saving a stitch pattern combination.....	67
	Loading a stitch pattern combination.....	67
	Overwriting a stitch pattern combination.....	67
	Deleting a stitch pattern combination.....	67
	Editing a single stitch pattern.....	68
	Deleting a single stitch pattern.....	68
	Adding a single stitch pattern.....	69
	Mirroring a stitch pattern combination.....	69
	Securing a stitch pattern combination.....	69
	Programming pattern repeat.....	70
5.6	Administering stitch patterns.....	70
	Saving settings of stitch patterns.....	70
	Saving stitch patterns in personal memory.....	70
	Overwriting stitch patterns from the personal memory.....	71
	Loading stitch patterns from the personal memory.....	71
	Deleting stitch patterns from the personal memory.....	71
	Saving stitch patterns on the BERNINA USB stick.....	71
	Uploading a stitch pattern from the BERNINA USB stick.....	72
	Deleting stitch patterns from the BERNINA USB stick.....	72
5.7	Securing.....	72
	Securing a seam with the button «Securing».....	72
5.8	Height Compensation of uneven layers.....	73
5.9	Sewing Corners.....	74

6	Practical stitches	75
6.1	Overview Practical stitches.....	75
6.2	Sewing straight stitch.....	77
6.3	Securing with the automatic Securing Program	78
6.4	Sewing in the zipper	78
6.5	Sewing both sides of the zipper from bottom to top	79
6.6	Sewing Triple Straight stitch.....	80
6.7	Sewing Triple zig zag	81
6.8	Manual darning	81
6.9	Automatic darning.....	83
6.10	Reinforced darning, automatic	84
6.11	Finishing edges	85
6.12	Sewing Double overlock.....	85
6.13	Narrow edgestitching.....	86
6.14	Wide edgestitching	86
6.15	Edgestitching using the seam guide (optional accessory)	86
6.16	Sewing hem edges.....	87
6.17	Sewing blind hems.....	88
6.18	Sewing visible hems	89
6.19	Sewing flat joining seams.....	89
6.20	Sewing basting stitches	90
7	Decorative stitches	91
7.1	Overview Decorative Stitches.....	91
7.2	Bobbin-Play.....	92
7.3	Sewing cross stitches.....	93
7.4	Pintucks	93
	Pintucks.....	93
	Overview pintucks	94
	Inserting the cord	94
	Sewing Pintucks	95
8	Alphabets	96
8.1	Overview Alphabet.....	96
8.2	Creating lettering.....	96
9	Buttonholes.....	98
9.1	Overview Buttonholes	98
9.2	Making use of the height compensation tool	99
9.3	Using the compensation plate	99
9.4	Marking buttonholes.....	100



9.5	Cord	101
	Using cord with the Buttonhole foot with slide No. 3A	101
	Using cord with the Buttonhole foot No. 3 (optional accessory)	102
9.6	Sewing a test sample	103
9.7	Determining the buttonhole slit width	103
9.8	Determining the buttonhole length with the Buttonhole foot with slide No. 3A	104
9.9	Determining the buttonhole length with the Buttonhole foot No. 3	104
9.10	Sewing a buttonhole automatically with the Buttonhole foot with slide No. 3A	105
9.11	Sewing the manual 7-step buttonhole	106
9.12	Sewing the manual 5-step buttonhole	107
9.13	Cutting the buttonhole open with the seam ripper	108
9.14	Cutting open buttonholes with the buttonhole cutter (optional accessory)	108
9.15	Sewing on buttons	108
9.16	Sewing eyelets	109
10	Quilting	110
10.1	Overview Quilt Stitches	110
10.2	Quilting, Securing Program	111
10.3	Sewing handlook quilt stitches	111
10.4	Guiding the quilt work freely	112
11	BERNINA Stitch Regulator (BSR) (optional accessory)	113
11.1	BSR mode 1	113
11.2	BSR mode 2	113
11.3	BSR function with Straight stitch No. 1	113
11.4	BSR function with Zig zag No. 2	113
11.5	Sewing preparations for quilting	113
	Attach the BSR presser foot	113
	Changing the presser foot sole	114
11.6	Using the BSR mode	114
11.7	Securing	115
	Securing in BSR1 mode with the button «Start/Stop»	115
	Securing in BSR2 mode	115
12	Attachment	117
12.1	Maintenance and cleaning	117
	Cleaning the display	117
	Cleaning the feed dog	117
	Cleaning the hook	117
	Lubricating the hook	118
12.2	Troubleshooting	120
12.3	Error messages	123
12.4	Storage and disposal	125
	Storing the machine	125
	Dispose of the machine	125



12.5	Technical data.....	126
13	Overview stitch patterns	127
13.1	Overview Stitch patterns	127
	Practical stitches	127
	Buttonholes.....	127
	Decorative stitches.....	127
	Index.....	131



IMPORTANT SAFETY INSTRUCTIONS

Please be aware of the following basic safety instructions when using your machine. Before using this machine, read instruction manual carefully.

DANGER!

To reduce the risk of electrical shock:

- Never leave the machine unattended as long as it is plugged in.
- Always unplug the machine from the electrical outlet immediately after using and before cleaning.

Protection against LED radiation:

- Do not view the LED light directly with optical instruments (e.g. magnifier). The LED light corresponds with protection class 1M.

Protection against injuries:

- Attention moving parts. To avoid injuries, switch off the machine before manipulations are carried out. Always close the cover when operating the machine.

WARNING

To reduce the risk of burns, fire, electric shock or injury to persons:

- To operate the machine always use the supplied power cable. The power cable for USA and Canada (power plug NEMA 1-15) must only be used for a power supply of maximal 150V against ground.
- Use this machine only for purposes as described in this manual.
- Do not use the machine outdoors.
- Do not use this machine as a toy. Close attention is necessary when this machine is used by or near children.
- The machine can be used by children older than 8 or by people with reduced physical, sensory or mental capabilities or if there is a lack of experience and knowledge how to operate the machine as long as they are supervised or have been given instruction concerning the responsible use of the appliance and are aware of the involved risks.
- Children are not allowed to play with this machine.
- Cleaning and maintenance work must not be carried out by children unless they are supervised.
- Never operate this machine if it has a damaged cord or plug, if it is not working properly, if it has been dropped or damaged, or dropped into water. Contact the nearest authorized BERNINA dealer to arrange further details.
- Only use accessories recommended by the manufacturer.
- Don't use this machine when the ventilation openings are blocked. Keep the ventilation openings free from the accumulation of lint, dust and loose cloth.
- Never insert any objects into any openings of the machine.



Servicing double-insulated products

In a double-insulated product two systems of insulation are provided instead of grounding. No grounding device is provided on a doubleinsulated product, nor should any grounding device be added to the product. Servicing a double-insulated product requires extreme care and knowledge of the system and should be done only by qualified service personnel. Replacement parts for a double-insulated product must be identical to the original parts in the product. A double-insulated product is marked with the words: «Double insulation» or «double-insulated».

The symbol may also be marked on the product.

KEEP THE INSTRUCTION MANUAL SAFE

Appropriate use

Your BERNINA machine is conceived and designed for private household use. It answers the purpose to quilt fabrics as it is described in this instruction manual. Any other use is not considered appropriate. BERNINA assumes no liability concerning consequences resulting from an inappropriate usage.



1 My BERNINA

1.1 Introduction

With your BERNINA 485 you can sew delicate silk or satin fabrics as well as heavy-weight linen, fleece and denim without any problems. Numerous practical, decorative stitches and buttonholes are at your disposal.

Additional to this instruction manual, subsequently listed help programs are provided which will give you useful advice and support at any time how to operate your BERNINA 485.

The **Tutorial** provides information and explanations on different sections concerning sewing and the various stitches.

The **Creative Consultant** informs you about decision support for sewing projects. After entering the kind of fabric and the desired sewing project, suggestions concerning the suitable needle or the appropriate presser foot are displayed.

The **Help Program** contains information about individual stitch patterns, functions and applications in the display.

Further information

In addition to this instruction manual of your BERNINA 485 further information products are enclosed.

The latest version of your instruction manual as well as additional information in connection with the machine and accessories can be found on our website <http://www.bernina.com>

1.2 Welcome to the world of BERNINA

Made to create, this is the slogan of BERNINA. Not only our machines do support you to implement your ideas. On top of that, our below mentioned opportunities also offer various inspirations and instructions for your future projects as well as the option to exchange ideas with other sewing and embroidering enthusiasts. We wish you lots of pleasure doing that.

BERNINA YouTube Channel

On YouTube we offer a wide range of how-to videos and support concerning the most important functions of our machines. Detailed explanations are also provided as for the various presser feet, so that your projects will succeed completely.

<http://www.youtube.com/BerninaInternational>

Provided in the languages English and German.

inspiration – the sewing magazine

Are you looking for ideas, sewing patterns and instructions for great projects? In that case the BERNINA magazine «inspiration» is exactly what you need. «inspiration» offers extraordinary sewing and embroidery ideas four times a year. From seasonal fashion trends to trendy accessories and practical tips to decorate your home in an original way.

<http://www.bernina.com/inspiration>

The magazine is available in the languages English, German, Dutch and French. Not available in all countries.

BERNINA Blog

Fancy instructions, free sewing patterns and embroidery motifs as well as many new ideas: all this you can find in the weekly blog by BERNINA. Our experts give valuable tips and explain step by step how you can achieve the desired result. In the community you can upload your own projects and exchange experiences and ideas with other sewing and embroidering enthusiasts.

<http://www.bernina.com/blog>

Provided in the languages English, German and Dutch.

BERNINA Social Media

Follow us on the social networking to learn more about events, thrilling projects as well as tips and tricks all about sewing. We will keep you informed and we are looking forward to presenting you the one or the other highlight from the world of BERNINA.

<http://www.bernina.com/social-media>

1.3 Key to signs



DANGER

Labels a danger with a high risk which can lead to death or severe injury unless it is avoided.



WARNING

Labels a danger with a medium risk which can lead to death or severe injury unless it is avoided.



CAUTION

Labels a danger with a low risk which can lead to light or medium injury unless it is avoided.

NOTICE

Labels a danger which can end up with damage unless it is avoided.



Tips given by BERNINA **sewing experts** can be found next to this sign.

By means of illustration, sample pictures are used in this instruction manual. The machines as well as the accessory shown in the pictures may vary from the delivery content of your machine.



1.4 Overview Machine

Overview front controls



- | | | | |
|---|---------------|----|--------------------------|
| 1 | Quick reverse | 6 | Needle up/down |
| 2 | Thread cutter | 7 | Presser foot pressure |
| 3 | Securing | 8 | Upper Multifunction knob |
| 4 | Start/Stop | 9 | Lower Multifunction knob |
| 5 | Pattern end | 10 | Needle left/right |

Overview front



- | | | | |
|---|---------------------|----|---------------------------------|
| 1 | Bobbin cover | 7 | Thread take-up lever cover |
| 2 | Presser foot | 8 | Thread take-up lever |
| 3 | Needle threader | 9 | Thread cutter |
| 4 | Sewing light | 10 | Needle fixing screw |
| 5 | Thread cutter | 11 | Connection for slide-on table |
| 6 | Slide speed control | 12 | Connection for Free Hand System |

Overview sideways



- | | | | |
|---|-----------------------------|----|--|
| 1 | Connection for foot control | 7 | Retractable spool pin |
| 2 | Feed dog up/down | 8 | Air vents |
| 3 | PC-connection | 9 | Handwheel |
| 4 | USB port | 10 | Power switch |
| 5 | Spool pin | 11 | Connection for power cable |
| 6 | Bobbin winding unit | 12 | Magnet holder for touchscreen pen (optional accessory) |

Overview back



- | | | | |
|---|-------------------------------|----|----------------------|
| 1 | Air vents | 9 | Bobbin winding unit |
| 2 | Connection for slide-on table | 10 | Thread pretension |
| 3 | Connection for darning hoop | 11 | Thread take-up lever |
| 4 | Presser foot lifter | 12 | Thread guide |
| 5 | Carrying handle | 13 | Thread cutter |
| 6 | Spool pin | 14 | BSR connection |
| 7 | Thread guide | 15 | Feed dog |
| 8 | Retractable spool pin | 16 | Stitch plate |

1.5 Supplied accessories

Overview accessories machine

All rights reserved: For technical reasons and for the purpose of product improvements, changes concerning the features of the machine can be made at any time and without advance notice. The supplied accessory can vary depending on the country of delivery.

Please visit www.bernina.com for more accessory information.

























Illustration	Name	Purpose
	Soft Cover with pocket	The soft cover protects the machine from dust and contamination.
	Accessory box	The accessory box serves the purpose to store the supplied accessories as well as the optional accessories.
	Knee lifter	The presser foot may be raised and lowered with the Free Hand System.
	Slide-on table	The slide-on table increases the sewing surface whereby the area of the free arm is not limited.
	3 Spool discs	Spool discs hold the thread spool in place for proper release of thread from the spool.
	4 Bobbins in the accessory, whereby 1 bobbin is already in the bobbin case	The bobbins are filled with the lower thread.
	1 Foam pad	The foam pad prevents the thread from getting hooked at the spool pin.
	Seam ripper	The seam ripper is an indispensable tool to undo stitches or to cut buttonholes open.

Illustration	Name	Purpose
	Height compensation tool	The height compensation tool levels an angled position of the presser foot sole when sliding over thick seams.
	Selection of needles	The needle assortment contains different versions and sizes of needles for all the common applications.
	Screwdriver red	The red screwdriver is supplied as an all-round tool.
	Brush	The brush is used to clean the feed dog and the hook area.
	Lubricator	The lubricator is used to fill up the oil depots.
	Power cable	The power cable connects the machine with the power supply system.
	Foot control	Via the foot control the machine is started and stopped. The speed of the machine is also controlled via the foot control. Always use the foot control of the type LV1 with this machine.

Use of the power cable (only USA/Canada)

The machine has a polarized plug (one blade wider than the other). To reduce the risk of electrical shock, this plug is intended to fit in a polarized outlet only one way. If the plug does not fit fully in the outlet, reverse the plug. If it still does not fit, contact a qualified electrician to install the proper outlet. Do not modify the plug in any way!

Overview presser feet

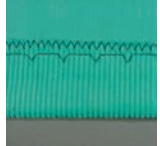
Illustration	Number	Name	Purpose	Example
	1	Reverse pattern foot	With the Reverse pattern foot you will succeed in sewing various practical and decorative stitches as well as sewing hems on heavy-weight fabrics such as cord, jeans or wool. The notch both in front and behind the stitch hole allows sewing stitches in forward and backward direction and ensures an excellent fabric feed.	
	2	Overlock foot	The Overlock foot suits perfectly to sew overlock seams and to finish edges in elastic material. The fabric edges don't curl and the result is a flat elastic seam.	
	3A	Automatic Buttonhole foot with slide	This foot is used to sew buttonholes with or without cord. The sensor can measure the buttonholes automatically on the base of the size of the desired button. Therefore any number of buttonholes can be sewn at exactly the same length. In combination with the compensation plate or the height compensating tool as well as the buttonhole cutter and the Button sew-on foot, perfect buttonholes can be worked out in a simple way.	
	4	Zipper foot	With the Zipper foot you will succeed in sewing in zippers in no time – in a proper and precise way. The narrow sole is positioned close along the zipper coils to sew the zipper adjacent to the edge.	
	5	Blind stitch foot	For blind stitch hems.	

Tab. 1: Standard accessories: Standard presser feet

Accessory box

All rights reserved: For technical reasons and for the purpose of product improvements, changes concerning the features of the machine can be made at any time and without advance notice. The supplied accessory can vary depending on the country of delivery.

The illustrated accessory (kind and quantity) serves as an example and doesn't have to correspond with the supplied accessory.



- | | | | |
|---|--------------|---|--------------------------------------|
| 1 | Drawer | 5 | Foam pad |
| 2 | Presser feet | 6 | Automatic Buttonhole foot with slide |
| 3 | Spool pin | 7 | Selection of needles |
| 4 | Spool discs | 8 | Presser foot holders for 5.5 mm feet |

1.6 Overview User Interface

Overview functions/visual information

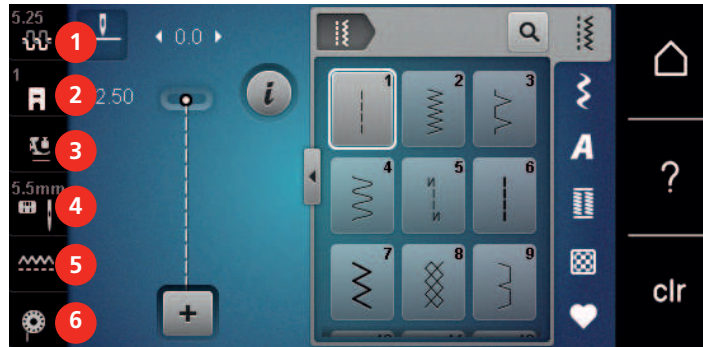

- | | | | |
|---|------------------------|---|---|
| 1 | Upper thread tension | 4 | Stitch plate/Needle selection |
| 2 | Presser foot indicator | 5 | Feed dog up/down |
| 3 | Presser foot pressure | 6 | Instruction how to thread the bobbin thread |

Overview System settings

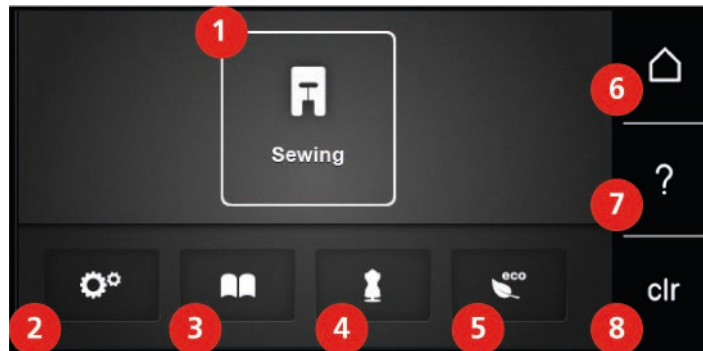

- | | | | |
|---|---------------------|---|-------------------------|
| 1 | Sewing mode | 5 | eco mode |
| 2 | Setup Program | 6 | Home |
| 3 | Tutorial | 7 | Help |
| 4 | Creative Consultant | 8 | Back to default setting |

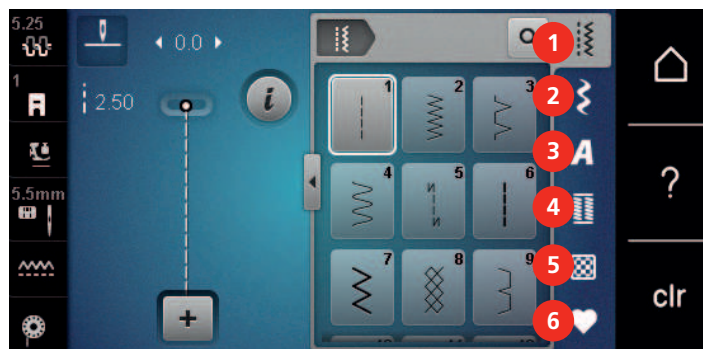

Overview selection menu sewing



- | | | | |
|---|---------------------|---|-----------------|
| 1 | Practical stitches | 4 | Buttonholes |
| 2 | Decorative stitches | 5 | Quilt stitches |
| 3 | Alphabets | 6 | Personal Memory |

Overview Icons

Icon	Name	Purpose
	i-Dialog	Touching the icon «i»-Dialog provides various functions to edit motifs.
	Close	The display is closed and the previously made adjustments are saved.
	Icons «-/+»	By touching the icons «-» and «+» the setting values are changed.
	Yellow frame around the icon	A yellow-framed icon indicates that a setting or a value in this function has been changed. By touching the yellow-framed icon, the default setting can be restored.
	Confirm	Confirms the previously adjusted alterations. The display is closed.
	Cancel	The process is canceled. The display is closed and the previously made adjustments are not saved.
	Slide	By moving the slide the setting values are changed.

Icon	Name	Purpose
	Switch	Activates or deactivates functions.
	Process navigation	With the process navigation scrolling back in the display is possible.
	Swipe function	By swiping the display using the touchscreen pen or the finger upwards or downwards, further functions can be displayed.

1.7 Needle, Thread, Fabric

In the course of time a needle wears out. Therefore it should be replaced regularly. Only a perfect point results in a good stitching result. In general it can be said: the thinner the thread, the finer the needle. The illustrated needles are either standard or optional accessory, depending on the machine.

- Needle sizes 70, 75: for thin fabrics.
- Needle sizes 80, 90: for medium fabrics.
- Needle sizes 100, 110 and 120: for heavy fabrics.

Overview needles

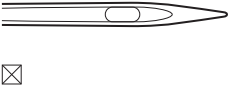
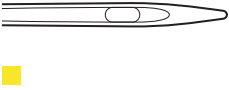
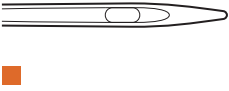
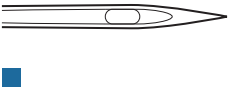



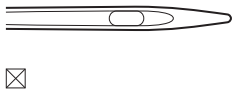

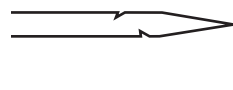

Illustration	Needle name	Needle description	Purpose
	Universal needle 130/705 H 60-120	Slightly rounded point	For nearly all natural and synthetic fabrics (woven and knitted).
	Stretch needle 130/705 H-S 75, 90	Medium ball point, special eye shape and channeling	Jersey, tricot, knit and stretch fabrics.
	Jersey/Embroidery needle 130/705 H SUK 60-100	Medium ball point	Knitware, embroidery.
	Jeans needle 130/705 H-J 80-110	Sharp fine point, reinforced shank	Heavy-weight fabrics such as jeans, canvas.
	Leather needle 130/705 H LR 90, 100	With cutting point (LR = special point to sew leather)	All types of leather, synthetic leather, plastic, sheeting.
	Microtex needle 130/705 H-M 60-110	Especially fine point	Micro fiber fabrics and silk.
	Quilting needle 130/705 H-Q 75, 90	Slightly rounded fine point	Straight and topstitching.

Illustration	Needle name	Needle description	Purpose
	Embroidery needle 130/705 H-E 75, 90	Small ball point, especially large needle eye and wide thread groove	Embroidery on all natural and synthetic fabrics.
	Fine material needle 130/705 H SES 70, 90	Fine ball point	Fine knitware, embroidering fine, delicate fabrics.
	Metafil needle 130/705 H METAFIL 80	Long needle eye (2 mm) in all needle sizes	Sewing projects with metallic threads.
	Cordonnet needle (to patch embroidery) 130/705 H-N 70-100	Long needle eye (2 mm) in all needle sizes	Topstitching with thick thread.
	Felt needle PUNCH	Needle with barbed hook	Felt work.
	Hemstitch needle 130/705 H WING 100-120	Wing-like widened needle shaft (wing)	Hemstitching.
	Universal double needle 130/705 H ZWI 70-100	Needle distance: 1.0/1.6/2.0/2.5/3.0/4.0/6.0/8.0	Visible hems in stretch fabrics: pintucks, decorative sewing.
	Stretch double needle 130/705 H-S ZWI 75	Needle distance: 2.5/4.0	Visible hems in stretch fabrics: pintucks, decorative sewing.
	Hemstitch double needle 130/705 H ZWIHO 100	Needle distance: 2.5	For special effects with hemstitch embroidery.
	Universal triple needle 130/705 H DRI 80	Needle distance: 3.0	Visible hems in stretch fabrics, pintucks, decorative sewing.

Example for needle description

The 130/705 system, which is the most common for household machines, is explained by the following picture of a Jersey/Stretch needle.

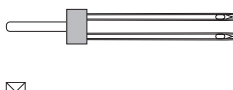
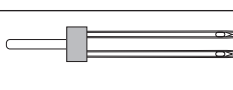
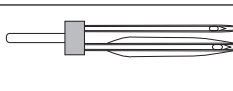
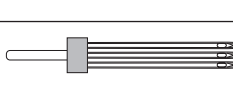
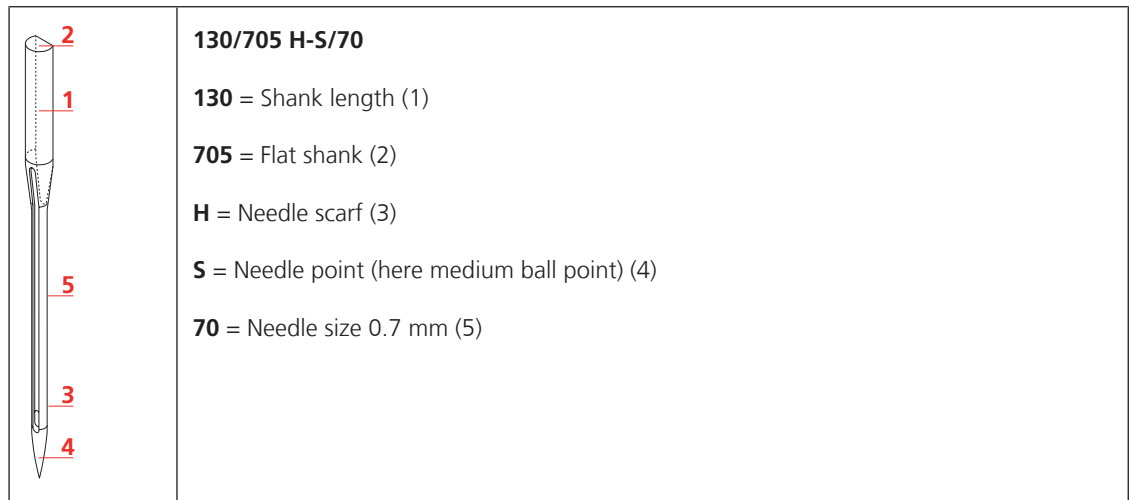

Thread selection

For a perfect sewing result, thread and fabric quality play an important role.

We recommend purchasing quality threads to achieve good sewing results.

- Cotton threads have the advantage of being a natural fiber and therefore are especially suitable for sewing cotton fabrics.
- Mercerized cotton threads have a slight sheen that is not lost with washing.
- Polyester threads have a high tensile strength and is particularly colorfast.
- Polyester threads are more flexible and are recommended where a strong and elastic seam is required.
- Rayon threads are made of natural fibers and have a brilliant sheen.
- Rayon threads are suitable for decorative stitches and achieve a more beautiful effect.

2 Sewing preparation

2.1 Accessory box

Removing and attaching the accessory box

The accessory box is fixed to the machine by means of four magnets. When attaching, the drawer has to be integrated in the accessory box.

- > Turn the carrying handle up and hold it in place.
- > Tilt the accessory box slightly to the front and pull off.



- > Close the doors of the accessory box.
- > Attach the accessory box to the machine, having the back towards the machine.

Storing accessories

NOTICE

Incorrect sorting of the bobbin

The silvery sensor surface can get scratched.

- > Make sure that the silvery sensor surfaces are on the right side when sorting the bobbins into the accessory box.

- > Insert the holders (1) for bobbins, feet and needles.
- > Store the small parts, e.g. lubricator etc., in the drawer (2).
- > Insert the bobbins into the compartment (3) of the accessory box so that the silvery sensor surfaces are on the right side.
- > To remove a bobbin, press the compartment holder down.
- > Place the small and the medium spool disc on the pin (4).
- > Store the foam pad in compartment (5).
- > Store the Buttonhole foot with slide No. 3A in compartment (6).
- > Store the provided needle package in the special compartment (7).
- > Store the presser feet in the holders (1).



2.2 Connection and Switching on

Connecting the foot control

- > Unwind the cable of the foot control to the desired length.



- > Insert the cable of the foot control into the foot control connection.



Connecting the machine

- > Insert the power cable into the power cord connection.



- > Insert the power cable into the power cord connection.

Attaching the knee lifter of the Free Hand System



The lateral position of the knee lifter can be adjusted by your local BERNINA Dealer if required.

- > Insert the knee lifter into the opening at the front side of the machine.

- > Release the foot control to stop the machine.



Raising/Lowering the needle

- > Sink the heel back on the foot control to raise/lower the needle.



2.4 Spool pin

Retractable spool pin

Lift the spool pin

The retractable spool pin is necessary when several threads are sewn and it can also be used for bobbin winding while sewing.

- > Press on the retractable spool pin with the finger and let go.
 - The retractable spool pin appears automatically.



Inserting foam pad and thread spool

The foam pad prevents the thread from getting hooked at the retractable spool pin.



- > Place the foam pad on the retractable spool pin.
- > Place the thread spool on the spool pin.



Horizontal spool pin

Placing the foam pad, the thread spool and the spool disc

The spool disc provides an even unwinding of the thread from the thread spool. The spool disc is only used with the horizontal spool pin.

- > Place the foam pad on the spool pin.
- > Place the thread spool on the spool pin.
- > Position the appropriate spool disc on the spool pin so that there is no space between the spool disc and the thread spool.



Using a spool net

The spool net keeps the thread on the thread spool and prevents the thread from knotting and breaking.

- > Pull the spool net over the thread spool.



2.5 Free arm

The BERNINA 485 provides a solidly designed free arm which offers a lot of space for large project on the right of the needle.

2.6 Feed dog

Adjusting the feed dog

NOTICE

Inappropriate handling of the fabric

Damage of the needle and the stitch plate.

> Let the sewing project be fed evenly.

With each stitch, the feed dog moves forward by one step. The length of this step is determined by the stitch length selected.

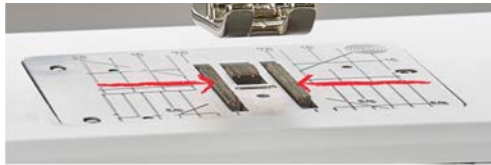

With a short stitch length, the steps are very short. For example when sewing buttonholes and satin stitches. The fabric is fed slowly under the presser foot, even when sewing at maximal speed.

	<p>Let the fabric be fed evenly; this results in a more perfect stitch formation.</p>
	<p>Pulling or pushing the fabric will result in uneven stitches.</p>
	<p>Holding back the fabric will result in uneven stitches.</p>

> Push the button «Feed dog up/down» to lower the feed dog.



> Push the button again to sew with the feed dog up.

Instruction for adjusting the feed dog



- > Touch the icon «Feed dog up/down».
- > Raise or lower the feed dog according to the animation.

2.7 Slide-on table

Using the slide-on table

When attached to the free arm, it expands the already existing sewing area.

- > Raise the needle.
- > Raise the presser foot.
- > Switch the machine off and disconnect it from the power supply system.
- > Push the slide-on table to the right over the free arm until it engages.



- > To remove the slide-on table, pull the slide-on table over the free arm to the left.



2.8 Presser foot

Adjusting the presser foot position via the knee lifter of the Free Hand System

- > Adjust the sitting height so that the knee lifter can be operated with the knee.
- > Push the knee lifter with the knee to the right to raise the presser foot.

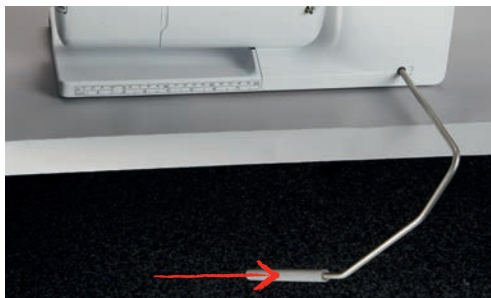

- Simultaneously the feed dog is lowered and the thread tension is released.
- > Release the knee lifter slowly to lower the presser foot.

Changing the presser foot

- > Raise the needle.
- > Raise the presser foot.
- > Switch the machine off and disconnect it from the power supply system.

- > Push the clamping lever up (1).
- > Remove the presser foot (2).



- > Guide the new presser foot upwards over the cone.
- > Press the clamping lever down.

Having the presser foot displayed in the User Interface

The recommended presser foot for the selected stitch is displayed. In addition to that, optional presser feet can be displayed.

- > Switch the machine on.
- > Select a stitch pattern.
 - In the icon «Presser foot display» the recommended presser foot is indicated with a number.



- > Touch the icon «Presser foot display».
- > With the touchscreen pen/finger scroll up within the range of presser feet to have optional presser feet displayed.
- > If a presser foot is touched, the description and the application for this presser foot is displayed.



Adjusting the presser foot pressure

The factory-set standard presser foot pressure can be used for all common sewing works. When working with jersey fabrics or with loose knitware, reduce the presser foot pressure. For firm materials, increase the presser foot pressure.



The presser foot pressure is designed to adjust the pressure of the presser foot optimally to the fabric thickness. When working with thick fabrics, it is recommended to reduce the presser foot pressure. This provides the advantage that the presser foot is slightly lifted so that the fabric can be moved more easily. When working with thin fabrics, it is recommended to increase the presser foot pressure. This provides the advantage that the fabric cannot be moved too easily under the presser foot.

- > Turn the knob to the right to reduce the pressure foot pressure.
- > Turn the knob further to the right to raise the presser foot.

Selecting the needle in the User Interface

After having changed the needle, it can be checked whether or not it can be used in combination with the selected stitch plate.



- > Touch the icon «Stitch plate/Needle selection».



- > Select the inserted needle.

Selecting the needle type and the needle size

Convenient memory function: To prevent a loss of information, the needle type and the needle size can be saved additionally on the machine. The saved needle type and the saved needle size can be checked at any time.



- > Touch the icon «Stitch plate/Needle selection».

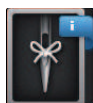

- > Touch the icon «Needle type/Needle size».
- > Select the needle type (1) of the inserted needle.
- > Select the needle size (2) of the inserted needle.



Adjusting the needle position up/down



- > Push the button «Needle up/down» to lower the needle.
- > Push the button «Needle up/down» again to raise the needle.

Adjusting the needle position left/right

There is a total of 11 needle positions. The needle position is indicated by the needle position number in the display.

- > Push the button «Needle left» (1) to move the needle to the left.

- > Push the button «Needle right» (2) to move the needle to the right.

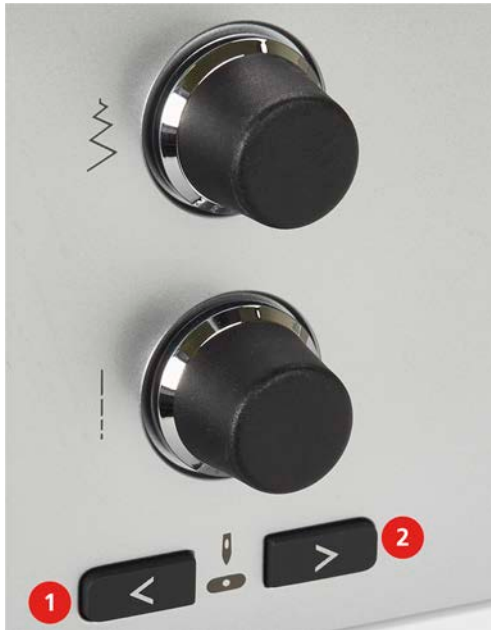

Needle stop up/down (permanent)



- > Touch the icon «Needle stop up/down (permanent)» to fix the needle position permanently.
 - The machine stops with needle position down as soon as the foot control is released or the button «Start/Stop» has been pressed.
- > Touch the icon «Needle stop up/down (permanent)» again.
 - The machine stops with needle position up as soon as the foot control is released or the button «Start/Stop» has been pressed.

Changing the stitch plate

The stitch plate is marked with vertical, horizontal and diagonal lines in millimeters (mm) and inches (inch). These lines help to guide the fabric when sewing seams and precise topstitching.

Prerequisite:

- The feed dog is lowered.
 - The machine is switched off and disconnected from the power supply system.
 - Needle and presser foot are removed.
- > Press the stitch plate down at the mark back right until it flips up.



- > Remove the stitch plate.
- > Place the openings of the new stitch plate above the corresponding guide pins and press down until it clicks into place.

Selecting the stitch plate in the User Interface

After having changed the stitch plate, it can be checked whether or not it is suitable to be used in combination with the selected needle.



- > Touch the icon «Stitch plate/Needle selection».
- > Select the previously attached the stitch plate.



- If the selected stitch plate is suitable in combination with the needle, sewing can be started.
- If the selected stitch plate is not suitable in combination with the needle, starting the machine is automatically blocked.

2.10 Threading

Threading the upper thread

Prerequisite:

- The needle and the foot are raised.
 - The machine is switched off and disconnected from the power supply system.
- > Place the foam pad on the spool pin.
 - > Place the thread spool on the spool pin so that the thread is unwound clockwise.
 - > Add the appropriate spool disc.
 - > Guide the thread in direction of the arrow through the rear thread guide (1) and hold the thread with the hands so that it is taut and can be inserted into the thread tension.
 - > Guide the thread in direction of the arrow through the thread tension (2).



- > Guide the thread downwards around the thread take-up lever cover (3).

- > Guide the thread upwards and insert into the thread take-up lever (4).



- > Guide the thread downwards again (5).
- > Guide the thread through the guides (6/7) above the foot.

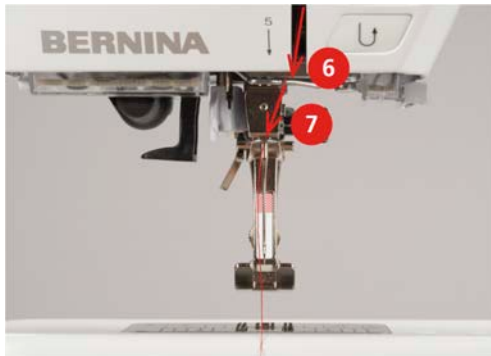

- > Switch the machine on.
- > Press the semi-automatic threader lever (8) slightly down, keep pressed and pull the thread to the left beneath the gray threader hook (9).

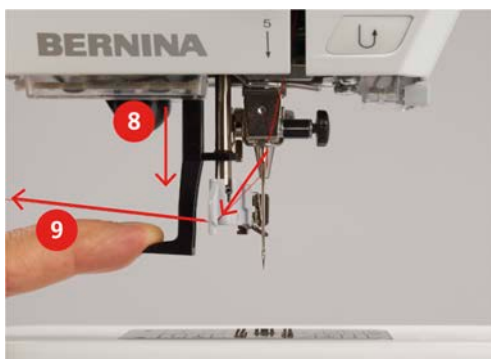

- > Guide the thread around the gray threader hook from the left to the right (11).
- > Press the threader lever down as far as it will go (10) and then pull the thread from the left to the right (11) through the threader slot (12) until it hooks into the small wire hook.
- > Pull the thread over the thread cutter (13) from the back and cut.

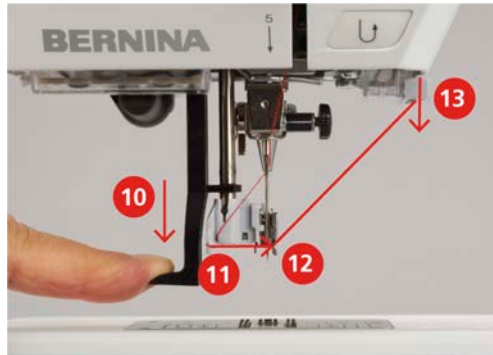

- > Release the lever to thread.
- > Pull the thread loop (14) to the back.

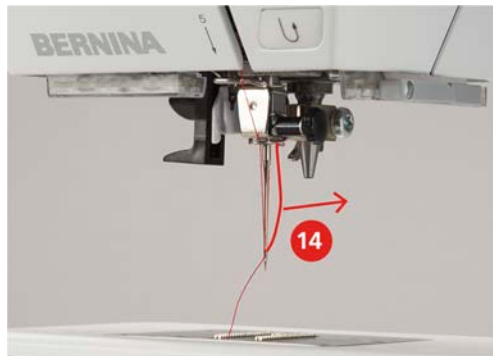

- > Pull the thread beneath the attached foot over the thread cutter (15) and cut.



Threading the double needle

Prerequisite:

- The double needle is inserted.
- > Guide the first thread in direction of the arrow on the right side of the tension disc (1).



- > Guide the second thread in direction of the arrow on the left side of the tension disc (1).

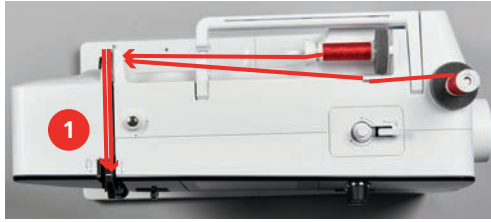

- > Guide the first and the second thread to the thread guide above the needle.
- > Thread the first thread manually into the right needle.
- > Thread the second thread manually into the left needle.

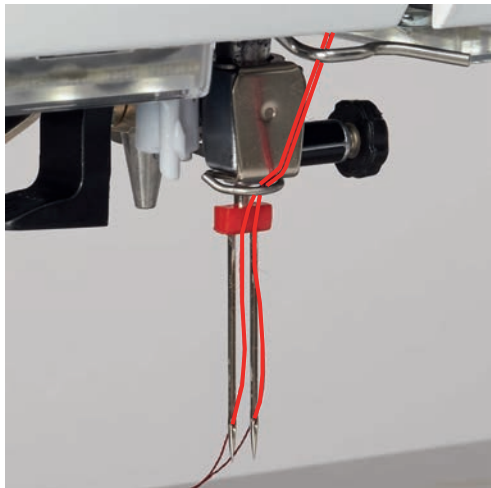

Threading the triple needle



Always insert a foam pad when using the retractable spool pin. It prevents the thread from getting hooked at the spool pin.

Prerequisite:

- The triple needle is inserted.
- > Place the foam pad, the thread spool and the appropriate spool disc on the spool pin.
- > Place the filled bobbin on the retractable spool pin.
- > Add the appropriate spool disc.
- > Place the thread spool.
- > Thread the 3 threads up to the upper thread guide.



- > Guide 2 threads past the thread tension discs on the left and to the thread guide above the needle.
- > Guide 1 thread past the thread tension disc on the right and to the thread guide above the needle.
- > Thread the first thread into the left needle manually.
- > Thread the second thread into the center needle manually.
- > Thread the third thread into the right needle manually.

Winding the bobbin thread



The bobbin thread can be wound while sewing when the retractable spool pin is used for winding.

Prerequisite:

- The foam pad, the thread spool and the appropriate spool disc are positioned.
- > Attach the empty bobbin on the winding unit so that the silvery sensor surface is down.



- > Guide the thread to the left into the rear thread guide (1).
- > Guide the thread around the thread pretension clockwise (2).
- > Wind the thread clockwise 2 to 3 times around the empty bobbin (3).
- > Pull the thread over the thread cutter at the engaging lever (4) and cut.

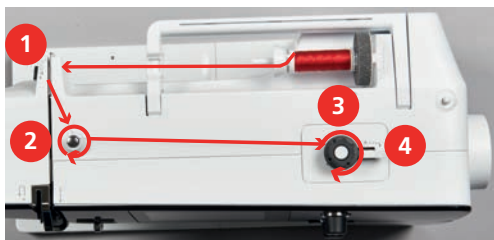

- > Push the engaging lever (5) towards the bobbin.



- The machine is winding.
- > To stop the winding process, the engaging lever must be pressed to the right.
- > Push the engaging lever towards the bobbin again to continue the winding process.
 - As soon as the bobbin is full, the machine stops the winding process automatically.
- > Remove the bobbin and cut the thread using the thread cutter at the engaging lever.

Threading the bobbin thread

Prerequisite:

- The needle is raised.
- The machine is switched off and the bobbin cover is opened.

- > Pull the thread to the right under the spring (3), then lead the thread under the two thread guides (4) and pull upwards.



- > When inserting into the machine, hold the bobbin case so the the thread guide (5) points upwards.

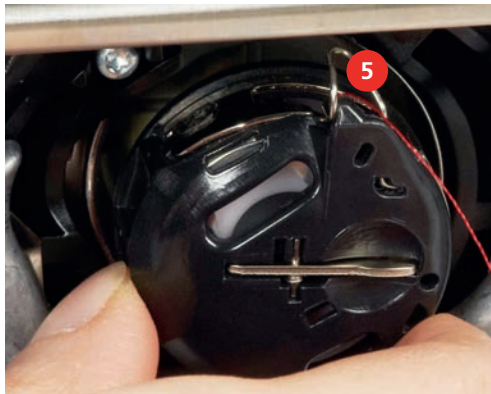

- > Insert the bobbin case.
- > Press onto the center of the bobbin case until it engages.
- > Pull the thread through the thread cutter (6) and cut.



- > Close the bobbin cover.

Instruction how to thread the bobbin thread



- > Touch the icon «Filling level bobbin thread».
- > Thread the bobbin thread according to the animation.



3 Setup Program

3.1 Sewing settings

Adjusting the upper thread tension

Adjustments to the upper thread tension in the Setup Program affect all stitch patterns. Individual alterations of the upper thread tension can also be made for currently selected stitches. The setting in the Setup remains active after switching off.



> Touch the icon «Home».



> Touch the icon «Setup Program».



> Touch the icon «Sewing settings».



> Touch the icon «Alter the upper thread tension».
> Move the slide using the touchscreen pen/finger or touch the icons «+» or «-» to alter the upper thread tension.

Adjusting the maximum sewing speed

By using this function, the maximum speed can be reduced.



> Touch the icon «Home».



> Touch the icon «Setup Program».



> Touch the icon «Sewing settings».



> Touch the icon «Alter the maximum speed».
> Move the slide using the touchscreen pen/finger or touch the icons «+» or «-» to alter the maximum speed.

Programming securing stitches

If the function is activated, 4 securing stitches are sewn automatically at the pattern start after the thread cut.



> Touch the icon «Home».



> Touch the icon «Setup Program».

Setup Program



> Touch the icon «Sewing settings».



> Touch the switch using the touchscreen pen/finger to deactivate the securing stitches.
> Touch the switch again to activate the securing stitches.

Programming the button «Thread cutter»

The automatic securing can be programmed before the thread cut takes place.



> Touch the icon «Home».



> Touch the icon «Setup Program».



> Touch the icon «Sewing settings».



> Touch the icon «Program buttons and icons».



> Touch the icon «Program the button thread cutter».



> Touch the icon «Securing» to sew 4 securing stitches in place.

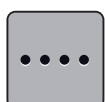

> Touch the icon «Alter the number of securing stitches» to program the number of securing stitches in close succession.
> Touch the icons «-» or «+» to program the number of securing stitches.

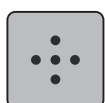

> Touch the icon «Securing stitches in place» to program 4 securing stitches in place.



> Touch the icon «Securing» deactivate the automatic securing.
> Touch the icon «Securing» again to activate the automatic securing.

Programming the button «Securing»

Number and type of securing stitches can be programmed.



> Touch the icon «Setup Program».



> Touch the icon «Sewing settings».



> Touch the icon «Setup Program».



> Touch the icon «Sewing settings».



> Touch the icon «Program the foot control».

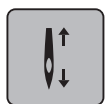

- The icon «Needle up/down» is activated by default.
- The back kick on the foot control raises or lowers the needle.



> Touch the icon «Program the back kick» to program the back kick.



> Touch the icon «Securing» to sew 4 securing stitches in place.

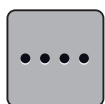

- > Touch the icon «Alter the number of securing stitches» to program subsequent securing stitches.
- > Touch the icons «-» or «+» to program the number of securing stitches.
- > Touch the yellow-framed icon to reset the alteration to default setting.

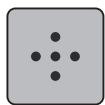

> Touch the icon «Securing stitches in place» to program 4 securing stitches in place.



- > Touch the icon «Securing» to deactivate the automatic securing via the back kick.
- > Touch the icon «Securing» again to activate the automatic securing via the back kick.



- > Touch the icon «Cut the thread» to deactivate the automatic thread cut.
- > Touch the icon «Cut the thread» again to activate the automatic thread cut via the back kick.

3.2 Selecting personal settings



> Touch the icon «Home».



> Touch the icon «Setup Program».



- > Touch the icon «Personal settings».
- > Select the desired color of the display and the background.

- > In the section (4) touch the icon «Loudspeaker» again to activate the signal when using the BSR modes.



3.4 Machine settings

Selecting a language

The User Interface can be programmed in different languages according to the customer's wish because BERNINA provides a wide range of international languages for the customers. Via firmware updates new languages are provided for the User Interface as appropriate.



- > Touch the icon «Home».



- > Touch the icon «Setup Program».



- > Touch the icon «Machine settings».



- > Touch the icon «Language selection».
- > Select a language.

Adjusting the brightness of the display

The brightness of the display can be adjusted corresponding to the personal preferences.



- > Touch the icon «Home».



- > Touch the icon «Setup Program».



- > Touch the icon «Machine settings».



- > Touch the icon «Adjust the brightness».
- > Move the slide using the touchscreen pen/finger or touch the icons «+» or «-» o alter the brightness of the display.

Checking the firmware version

Both the firmware and the hardware version of the machine are displayed.



> Touch the icon «Home».



> Touch the icon «Setup Program».



> Touch the icon «Machine settings».



> Touch the icon «Information».



> Touch the icon «Firmware and Hardware Information».

Reviewing the total number of stitches

The total number of stitches of the machine as well as the number of stitches since the last service carried out by the specialized BERNINA dealer are displayed.



> Touch the icon «Home».



> Touch the icon «Setup Program».



> Touch the icon «Machine settings».



> Touch the icon «Information».



> Touch the icon «Firmware and Hardware Information».

Registering details of the dealer

The contact details of your specialized BERNINA dealer can be registered.



> Touch the icon «Home».



> Touch the icon «Setup Program».





> Touch the icon «Machine settings».



> Touch the icon «Information».



> Touch the icon «Dealer details» to enter the information of the specialized dealer.



> Touch the icon «Name of the shop» to enter the name of the specialized BERNINA dealer.



> Touch the icon «Address» to enter the address of the specialized BERNINA dealer.



> Touch the icon «Phone» to enter the telephone number of the specialized BERNINA dealer.



> Touch the icon «Internet» to enter the Internet homepage or the email address of the specialized BERNINA dealer.

Saving Service data

Service data concerning the status quo of the machine can be saved on a BERNINA USB stick (optional accessory) and then given to the BERNINA dealer.

> Insert a BERNINA USB stick (Optional accessory) which provides enough free memory space into the USB port.



> Touch the icon «Home».



> Touch the icon «Setup Program».



> Touch the icon «Machine settings».



> Touch the icon «Information».



> Touch the icon «Service data».
> Touch the icon «LOG».
– The icon «LOG» is outlined in white.

> Only when the icon is not outlined in white anymore, remove the BERNINA USB Stick (optional accessory).

Back to default setting

ATTENTION: Using this function will delete all individually made settings.



> Touch the icon «Home».



> Touch the icon «Setup Program».



> Touch the icon «Machine settings».



> Touch the icon «Default settings».



> Touch the icon «Default setting sewing».



> Touch the icon «Confirm» to restore the default settings for the sewing settings.



> Touch the icon «Default setting all».



> Touch the icon «Confirm» and restart the machine to restore all default settings.

Deleting user data

Motifs which are not needed anymore can be deleted so that there will be more capacity for new motifs.



> Touch the icon «Home».



> Touch the icon «Setup Program».



> Touch the icon «Machine settings».



> Touch the icon «Default settings».



> Touch the icon «Delete data from the personal memory».



> Touch the icon «Confirm» to delete all data from the personal memory.

Calibrating the Buttonhole foot No. 3A

The Buttonhole foot No. 3A is calibrated to this machine and they should only be used both together.

Prerequisite:

- The Buttonhole foot No. 3A is attached.
- The needle is not threaded.

Setup Program



> Touch the icon «Home».



> Touch the icon «Setup Program».



> Touch the icon «Machine settings».



> Touch the icon «Maintenance/Update».



> Touch the icon «Calibrate the Buttonhole foot with slide No. 3A».
> Lower the Buttonhole foot with slide No. 3A.



> Touch the button «Start/Stop» to start the calibration.



> After the calibration is finished, touch the icon «Close».

Updating the machine Firmware

NOTICE

The BERNINA USB stick (optional accessory) has been removed too early

Firmware has not been updated and the machine cannot be used.

> Remove the BERNINA USB stick (optional accessory) only after the update has been completed successfully.

The latest firmware of the machine and a detailed step-by-step instruction for updating processes can be downloaded at www.bernina.com. In general, personal data and settings are automatically transferred during a firmware update. For reasons of safety, it is also recommended to save data and settings on a BERNINA USB stick (optional accessory) before the firmware update is started. If personal data and settings should get lost during a firmware update, they can be transferred to the machine again afterwards.

> Insert the BERNINA USB Stick (optional accessory), FAT32 formatted, providing the latest software into the port.



> Touch the icon «Home».



> Touch the icon «Setup Program».



> Touch the icon «Machine settings».



> Touch the icon «Maintenance/Update».



> Touch the icon «Update the machine».



> Touch the icon «Save data on USB Stick».
– The icon is checkmarked in green.



> Touch the icon «Update» to start the update of the firmware.

Recovering saved data

NOTICE

The BERNINA USB stick (optional accessory) has been removed too early

Saved data cannot be transferred and the machine cannot be used.

> Remove the BERNINA USB stick (optional accessory) only after the saved data has been transferred successfully.

If personal data and settings after a software update are not available anymore, they can be transferred to the machine again afterwards.

> Insert the BERNINA USB stick (Optional accessory) providing the saved data and settings into the USB port of the machine.



> Touch the icon «Home».



> Touch the icon «Setup Program».



> Touch the icon «Machine settings».



> Touch the icon «Maintenance/Update».



> Touch the icon «Update the machine».

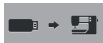

> Touch the icon «Transfer saved data to machine».
– The icon is checkmarked in green.

Cleaning the thread catcher

In chapter «Maintenance and cleaning» there are additional illustrated step-by-step instructions.



> Touch the icon «Home».



> Touch the icon «Setup Program».

Setup Program



> Touch the icon «Machine settings».



> Touch the icon «Maintenance/Update».



> Touch the icon «Clean the thread catcher».

> Clean the thread catcher according to the instructions on the display.

Lubricating the machine



Electronically driven components

Risk of injury near the needle and the hook.

> Switch the machine off and disconnect it from the power supply system.



Lubricating the hook

Too much oil can pollute the fabric and the thread.

> Always sew a test sample first.

The Setup Program provides animations how the machine has to be oiled. In chapter «Maintenance and cleaning» there are more illustrated step by step instructions. Always use BERNINA oil to lubricate.



> Touch the icon «Home».



> Touch the icon «Setup Program».



> Touch the icon «Machine settings».



> Touch the icon «Maintenance/Update».



> Touch the icon «Lubricate the machine».

> Lubricate the machine according to the instructions on the display.

4 System settings

4.1 Calling up the Tutorial

The Tutorial provides information and explanations on different sections concerning sewing and the various stitches.



> Touch the icon «Home».



> Touch the icon «Tutorial».
> Select the desired topic to get information.

4.2 Calling up the Creative Consultant

The Creative Consultant provides information about decision support concerning sewing projects. After entering the fabric and the desired sewing project, suggestions for suitable needles, presser feet etc. are displayed.

Prerequisite:

- Sewing mode is active.



> Touch the icon «Home».



> Touch the icon «Creative Consultant».
> Select the fabric to be sewn.
> Select the sewing project.

4.3 Using eco mode

During a longer interruption of work the machine can be set into a power save mode.



> Touch the icon «Home».



> Touch the icon «eco mode».
– The display goes to sleep. The power consumption is reduced and the sewing light is off.
> Touch «eco».
– The machine is ready for use.

4.4 Calling up the Help



> Touch the window in the display where help is needed.
> Touch the icon «Help» to start the help mode.
> Touch the icon in the display where help is needed.
– Assistance concerning the selected icon is displayed.

4.5 Cancelling any alterations with «clr»

Any alterations to motifs can be reset to default setting. Exceptions are saved motifs which have been filed in the personal memory and monitoring functions.



> Touch the icon «clr».



5 Creative sewing

5.1 Overview selection menu sewing

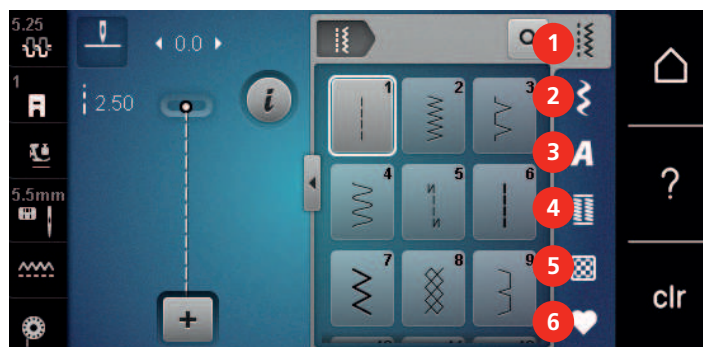

- | | | | |
|---|---------------------|---|-----------------|
| 1 | Practical stitches | 4 | Buttonholes |
| 2 | Decorative stitches | 5 | Quilt stitches |
| 3 | Alphabets | 6 | Personal Memory |

Selecting a stitch pattern

- > Select a stitch pattern, an alphabet or a buttonhole.
- > With the touchscreen pen/finger scroll up within the range of the practical stitches to have more stitch patterns displayed.
- > Touch the icon «Display all the stitch patterns» (1) to scale up the view.
- > Touch the icon «Display all the stitch patterns» (1) again to downsize the stitch pattern view.

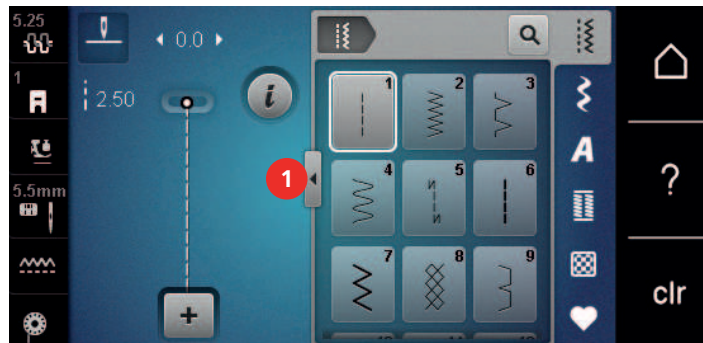

- > Touch the icon «Stitch pattern number entry» to select the stitch pattern via entering the stitch number.

5.2 Regulating the speed

The speed is infinitely variable with the slide-speed control.



- > Move the slide-speed control to the left to reduce the speed.
- > Move the slide-speed control to the right to increase the speed.

5.3 Adjusting the upper thread tension

The default setting of the upper thread tension is made automatically as soon as a stitch pattern is selected.

The upper thread tension is set optimally at the BERNINA factory and the machine has been tested.

Metrosene-/Seralon thread size 100/2 (Company Mettler, Switzerland) is used for upper and bobbin thread.

When of using other types of sewing threads, the optimal upper thread tension may vary. Therefore it may be necessary to adjust the upper thread tension individually according to the sewing project as well as the desired stitch pattern.

The higher the upper thread tension, the tighter the upper thread which means that the bobbin thread is pulled up to the top of the fabric. When the upper thread tension is low, the upper thread is less tightened which means that the bobbin thread is pulled up less.

Alterations of the upper thread tension affect the currently selected stitch pattern. Permanent alterations of the upper thread tension for the sewing mode (see page 49) can be made in the Setup Program.

Prerequisite:

- In the Setup Program the upper thread tension has been altered.
- > Touch the icon «Upper thread tension».
- > Move the slide using the touchscreen pen/finger to increase or reduce the upper thread tension.



- > Touch the yellow-framed icon on the right to reset the alterations to default setting.
- > Touch the yellow-framed icon on the left to reset the alterations to default setting in the **Setup Program**.

5.4 Editing stitch patterns

Changing the stitch width

- > Turn the «Upper Multifunction knob» to the left to narrow the stitch width.
- > Turn the «Upper Multifunction knob» to the right to widen the stitch width.
- > Touch the icon «Stitch width» (1).

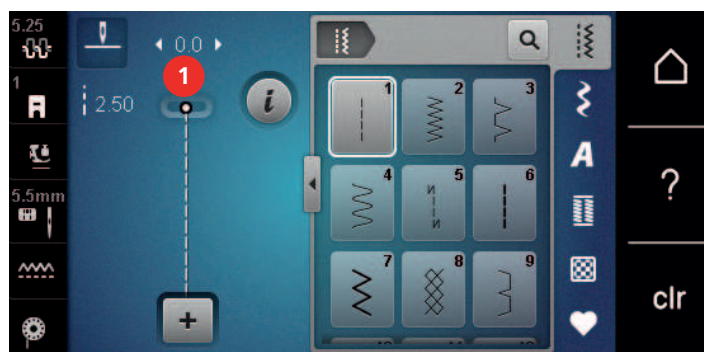

- > Touch the yellow-framed icon to reset the alteration to default setting.

Changing the stitch length

- > Turn the «Lower Multifunction knob» to the left to shorten the stitch length.
- > Turn the «Lower Multifunction knob» to the right to elongate the stitch length.

- > Touch the icon «Stitch length» (1).

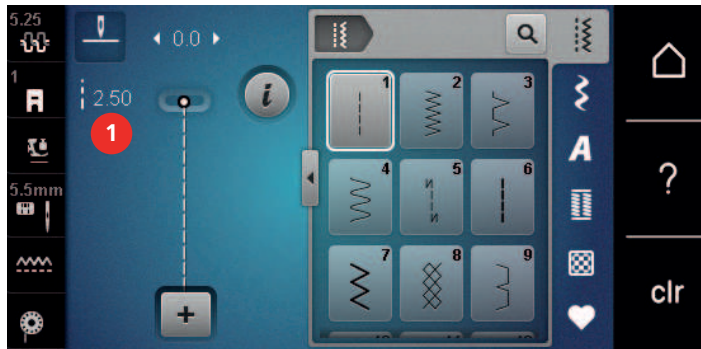

- > Touch the yellow-framed icon to reset the alteration to default setting.

Correcting the balance

Different fabrics, threads and stabilizers can affect the programmed stitch patterns so that they cannot be sewn out correctly. The electronic balance can correct these deviation and the stitch pattern can be adjusted optimally to the selected fabric.

- > Select a stitch pattern or alphabet.
- > Touch the icon «i»-Dialog.



- > Touch the icon «Balance».
- A preview of the stitch pattern is displayed.

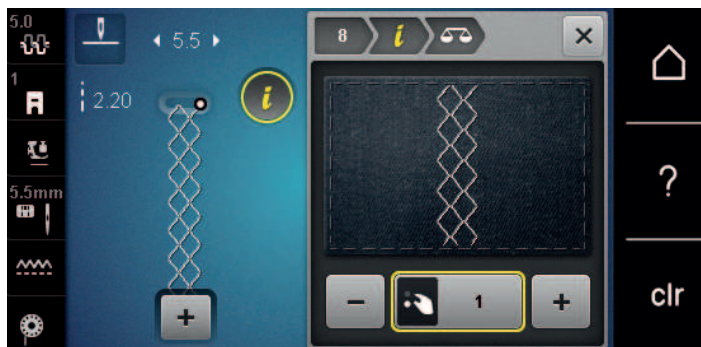

- > To correct the vertical direction of the stitch pattern, turn the «Lower Multifunction knob» until the preview of the stitch pattern is in accordance with the sewn stitch on the fabric.
- > To save the alterations, close the preview window or touch the icon «i»-Dialog.

Programming pattern repeat

Stitch patterns can be repeated up to 9 times.

- > Select a stitch pattern or an alphabet.
- > Touch the icon «i»-Dialog.



- > Touch the icon «Pattern repeat» once to repeat the stitch pattern.
- > Touch the icon «Pattern repeat» again to repeat the stitch pattern up to 9 times.
- > Keep the icon «Pattern repeat» pressed to deactivate the stitch pattern repeat.



Mirror image of stitch patterns

- > Select a stitch pattern or alphabet.
- > Touch the icon «i»-Dialog.



- > Touch the icon «Mirror image left/right» to mirror the stitch pattern from left to right.



- > Touch the icon «Mirror image up/down» to mirror the stitch pattern contrary to the sewing direction.
- > Touch the yellow-framed icon to reset the alteration to default setting.



Quick reverse

- > Select a stitch pattern, alphabet or buttonhole.
- > Program needle stop down (permanent) to switch immediately to Quick reverse as soon as the button «Quick reverse» is pressed.
- > Program needle stop up (permanent) to sew another stitch forward before the machine switches to reverse sewing.

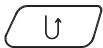

- > Push the button «Quick reverse» and keep pressed.

Permanent Quick reverse

- > Select a stitch pattern or alphabet.
- > Touch the icon «i»-Dialog.



- > Touch the icon «Permanent reverse sewing» to sew permanently in reverse.

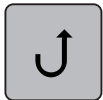

5.5 Combining stitch patterns

Overview Combi mode



- | | | | |
|---|--|---|--|
| 1 | Stitch width of the active stitch pattern | 3 | Combi mode/Single mode |
| 2 | Stitch length of the active stitch pattern | 4 | Individual stitch pattern within a combination |

Creating Stitch pattern combinations

In the Combi mode stitch patterns and alphabets can be combined according to your wish. By combining any alphabet letters, the logo BERNINA can be created.

- > Touch the icon «Single/Combi mode».
- > Select the desired stitch patterns.



- > Touch the icon «Single/Combi mode» again to return to the single mode.

Saving a stitch pattern combination

- > Create a stitch pattern combination.
- > Touch the icon «Personal memory».



- > Touch the icon «Save stitch pattern».



- > Touch the icon «Confirm» or the yellow-framed icon to save the stitch pattern combination.



Loading a stitch pattern combination

- > Touch the icon «Single/Combi mode».



- > Touch the icon «Personal memory».



- > Touch the icon «Selection of stitch pattern combination».
- > Select a stitch pattern combination.



Overwriting a stitch pattern combination

- > Create a stitch pattern combination.
- > Touch the icon «Personal memory».



- > Touch the icon «Save stitch pattern».
- > Select the stitch pattern combination which is to be overwritten.



- > Touch the icon «Confirm» to overwrite the stitch pattern combination.



Deleting a stitch pattern combination

- > Create a stitch pattern combination.
- > Touch the icon «i»-Dialog.



- > Touch the icon «Edit the whole combination».

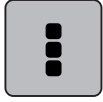

- > Touch the icon «Delete».



- > Touch the icon «Confirm».



Editing a single stitch pattern

- > Create a stitch pattern combination.
- > With the touchscreen pen/finger touch the desired position (1) within the stitch pattern combination to select a single stitch pattern.



- > Touch the icon «i»-Dialog to edit the single stitch pattern.



Deleting a single stitch pattern

- > Create a stitch pattern combination.
- > With the touchscreen pen/finger touch the desired position (1) within the stitch pattern combination to select a single stitch pattern.

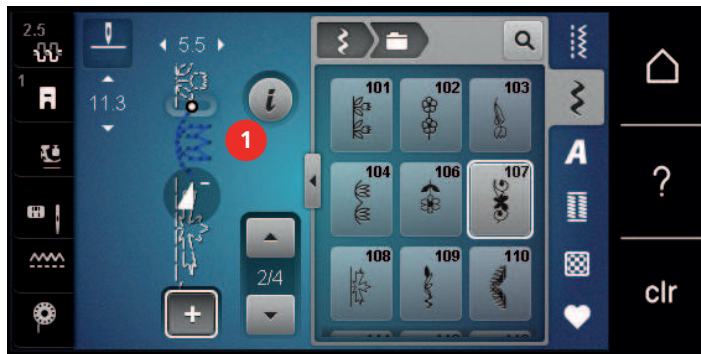



- > Touch the icon «i»-Dialog.



- > Touch the icon «Delete» to delete the individual stitch pattern

or

- > touch the desired stitch pattern (1) with the touchscreen pen/finger, keep it touched and move it outwards.

- The stitch pattern is deleted.



Adding a single stitch pattern

The new stitch pattern is always inserted **after** the selected stitch pattern.

- > Create a stitch pattern combination.
- > With the touchscreen pen/finger touch the desired position (1) within the stitch pattern combination to select a single stitch pattern.

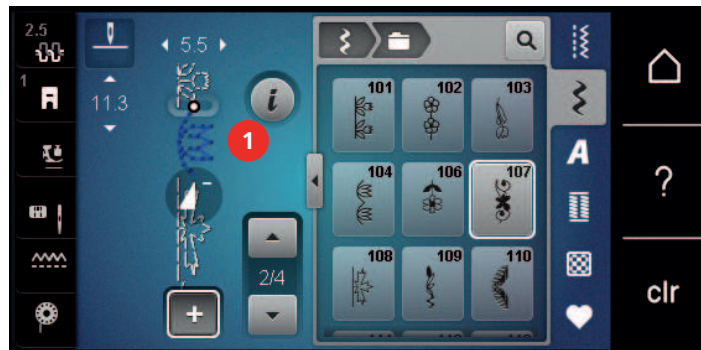

- > Select a new stitch pattern.

Mirroring a stitch pattern combination

- > Create a stitch pattern combination.
- > Touch the icon «i»-Dialog.

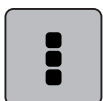

- > Touch the icon «Edit the whole combination».



- > Touch the icon «Mirror image left/right» to mirror the whole stitch pattern combination from the left to the right.
- > Touch the icon «Mirror image left/right» again to reset the alterations to default setting.

Securing a stitch pattern combination

- > Create a stitch pattern combination.
- > With the touchscreen pen/finger select the desired position within the stitch pattern combination where the stitch pattern combination is to be secured.
- > Touch the icon «i»-Dialog.

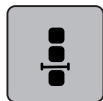

- > Touch the icon «Edit combination at cursor position».



- > Touch the icon «Securing».
 - Every single pattern of the stitch pattern combination can be secured at the start or at the end.

Programming pattern repeat

- > Create a stitch pattern combination.
- > Touch the icon «i»-Dialog.

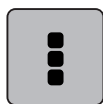

- > Touch the icon «Edit the whole combination».



- > Touch the icon «Pattern repeat» once to repeat the stitch pattern combination.
- > Touch the icon «Pattern repeat» again to repeat the stitch pattern combination up to 9 times.
- > Keep the icon «Pattern repeat» pressed to deactivate the pattern repeat.

5.6 Administering stitch patterns

Saving settings of stitch patterns

- > Select a stitch pattern, alphabet or buttonhole.
- > Touch the icon «i»-Dialog.
- > Edit the stitch, alphabet or buttonhole.



- > Touch the icon «Saving stitch pattern settings» to save the alterations permanently.



- > Touch the icon «Back to default setting» to cancel the alterations.

Saving stitch patterns in personal memory

In the filing system «Personal memory» any stitch patterns, also those which have been individually edited, can be saved.

- > Select a stitch pattern, alphabet or buttonhole.
- > Edit the stitch pattern.



> Touch the icon «Personal memory».



> Touch the icon «Save stitch pattern».
> Select the file where the pattern is to be saved.



> Touch the icon «Confirm».

Overwriting stitch patterns from the personal memory

Prerequisite:

- The stitch pattern is saved in the personal memory.
- > Select a stitch pattern, alphabet or buttonhole.
- > Edit the stitch pattern.
- > Touch the icon «Personal memory».



> Touch the icon «Save stitch pattern».
> Select the file where the stitch pattern to be overwritten has been saved.
> Select the stitch pattern which should be overwritten.



> Touch the icon «Confirm».

Loading stitch patterns from the personal memory

Prerequisite:

- The stitch pattern is saved in the personal memory.
- > Touch the icon «Personal memory».



> Touch the icon «Stitch pattern selection».
> Select the file where the stitch pattern has been saved.
> Select a stitch pattern.

Deleting stitch patterns from the personal memory

Prerequisite:

- The stitch pattern is saved in the personal memory.
- > Touch the icon «Personal memory».



> Touch the icon «Delete».
> Select the file where the stitch pattern has been saved.
> Select a stitch pattern.



> Touch the icon «Confirm» to delete the stitch pattern.

Saving stitch patterns on the BERNINA USB stick

On the BERNINA USB stick stitch patterns, also those which have been individually edited, can be saved.

- > Select a stitch pattern, alphabet or buttonhole.
- > Edit the stitch pattern.





> Touch the icon «Personal memory».



> Touch the icon «Save stitch pattern».



> Insert the BERNINA USB stick into the USB port of the machine.

> Touch the icon «USB Stick».



> Touch the icon «Confirm».

Uploading a stitch pattern from the BERNINA USB stick



> Touch the icon «Personal memory».



> Touch the icon «Load stitch pattern».

> Touch the icon (1).

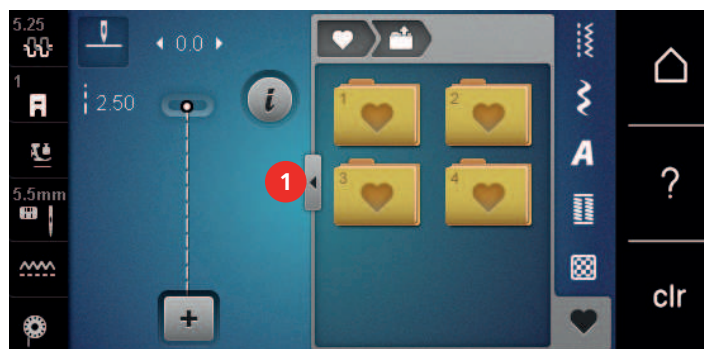

> Insert the BERNINA USB stick into the USB port of the machine.

> Touch the icon «USB stick».

> Select the desired stitch pattern.

Deleting stitch patterns from the BERNINA USB stick



> Touch the icon «Personal memory».



> Touch the icon «Delete».

> Insert the BERNINA USB stick into the USB port of the machine.

> Select the stitch pattern which is to be deleted.



> Touch the icon «Confirm».

5.7 Securing

Securing a seam with the button «Securing»

The button «Securing» can be programmed with various securing stitches.



> Push the button «Securing» before starting to sew.

- The stitch pattern/stitch pattern combination will be secured with the number of programmed stitches when sewing is started.

> Push the button «Securing» while sewing.

- The machine stops immediately and secures with the number of programmed stitches.

5.9 Sewing Corners

When sewing corners, only a small section of the fabric is actually on the feed dog. Therefore it cannot grip the fabric well. By means of the height compensation tool the fabric can be fed evenly.

- > When the fabric edge is reached, stop the sewing process with needle position down.
- > Raise the presser foot.
- > Turn the fabric and place in desired position.
- > Place 1 – 3 compensating plates as required on the right of the presser foot close to the sewing project.
- > Lower the presser foot.

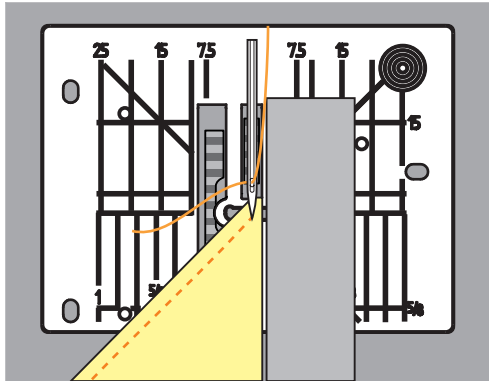







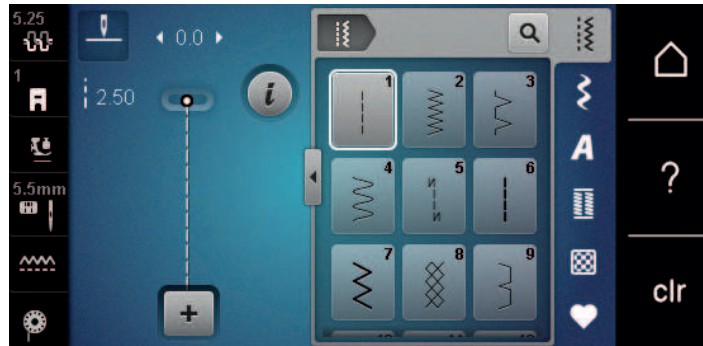









- > Resume sewing until the sewing project is on the feed dog again.

6 Practical stitches

6.1 Overview Practical stitches



Stitch pattern	Stitch number	Name	Description
	1	Straight stitch	Seams and topstitching.
	2	Zig zag	Reinforcing seams, finishing edges, sewing elastic seams and attaching lace.
	3	Vari overlock	Sewing and finishing in one step of elastic fabrics.
	4	Running stitch	Darning with running stitch, mending fabrics, reinforcing edges.
	5	Securing Program	Securing starts and ends of seams by straight stitching.
	6	Triple Straight stitch	For durable seams in heavy fabrics; visible hems and seams.
	7	Triple Zig zag	For durable seams in heavy fabrics; visible hems and seams.
	8	Honeycomb stitch	For elastic fabrics and hems. also used with elastic bobbin threads.
	9	Blind stitch	Blind hems, shell edging effect on soft jerseys and fine material, decorative seams.
	10	Double overlock	Sewing and finishing in one step of elastic fabrics.
	11	Superstretch stitch	For highly stretch and open seams. all types of clothing.

Stitch pattern	Stitch number	Name	Description
	12	Gathering stitch	Most types of fabric; gathering with shirring elastic, butted seams = butting two pressed edges and sewing together, decorative stitches.
	13	Stretch overlock	Sewing and finishing elastic fabrics in one step.
	14	Tricot stitch	Visible hems, visible seams in lingerie, sweaters, mending jersey.
	15	Universal stitch	For firm fabrics such as felt and leather. Flat joining seams, visible seams, attaching elastic, decorative seams.
	16	Sewn-out Zig zag	Edge finishing and reinforcing, attaching elastic, decorative seam.
	17	Lycra stitch	For lycra fabrics; flat joining seams and hems, reinforced seaming on underwear.
	18	Stretch stitch	For highly stretch fabrics, open seam for sportswear.
	19	Reinforced overlock	For medium-weight knitware and toweling. Overlock seams, flat joining seams.
	20	Knit overlock	Sewing and finishing in one step of hand and machine knitted fabrics.
	22	Simple Darning Program	Darning of holes and damaged fabric.
	23	Reinforced Darning Program	Reinforcing darning holes and damaged fabric.
	24	Bartack Program	Reinforcing pocket openings, sewing on belt loops.
	25	Bartack Program	Reinforcing pocket openings, sewing on belt loops, securing zippers and seam ends.
	26	Large Fly stitch	Reinforcing pocket openings, zippers and slits in medium-weight to thick fabrics.
	29	Narrow Blindstitch	For blind hems in fine fabrics.
	30	Basting stitch	For basting seams, hems, quilts, etc.



Stitch pattern	Stitch number	Name	Description
	32	Single Straight stitch	Used as a connecting stitch in a combination.
	33	Three Single Straight stitches	As connecting stitches in a combination.

6.2 Sewing straight stitch

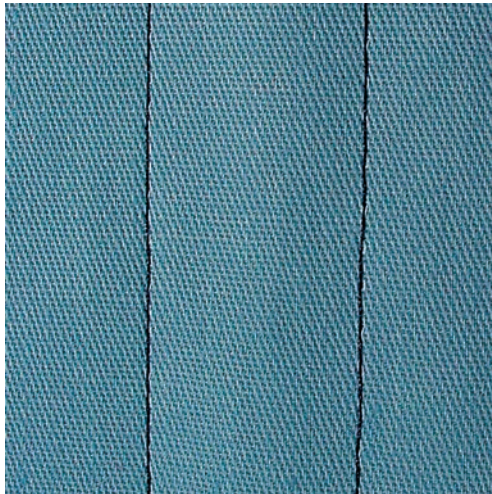

Match the stitch length with the sewing project, which means for denim fabrics long stitches (ca. 3 – 4 mm), for fine fabrics short stitches (ca. 2 – 2.5 mm). Match the stitch length with the thread size, e.g. long stitches when topstitching with Cordonnet (ca. 3 – 5 mm).

The straight stitch, also called step stitch, is the most used stitch.

Prerequisite:

- The Reverse pattern foot No. 1 is attached.
- > Touch the icon «Practical stitches».
- The Straight stitch No. 1 is selected automatically.



6.3 Securing with the automatic Securing Program

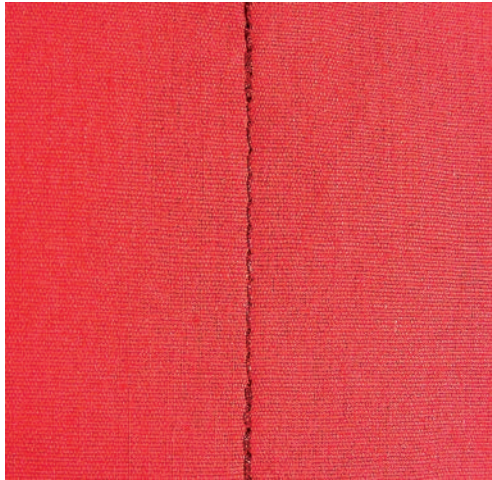

Due to a defined number of sewn stitches, 5 stitches forward and 5 stitches in reverse, securing is done evenly.

Prerequisite:

- The Reverse pattern foot No. 1 is attached.



- > Touch the icon «Practical stitches».
- > Select the Securing Program No. 5.
- > Press the foot control.
 - The machine secures automatically.

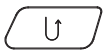

- > Sew the seam in the desired length.
- > Push the button «Quick Reverse».
 - The machine secures automatically and stops at the end of the securing program.

6.4 Sewing in the zipper

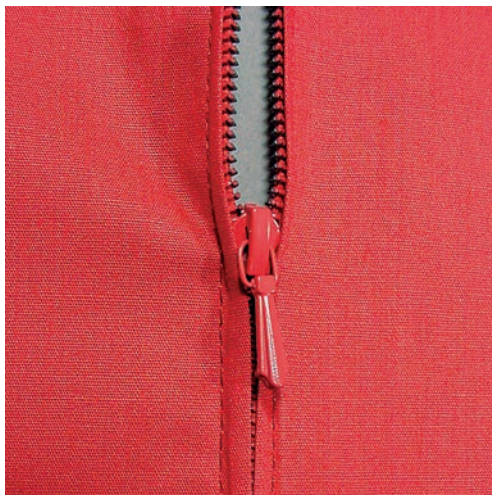

As the fabric feed can be difficult when starting to sew, it is recommended to hold the threads firmly or to pull the fabric slightly to the back for a few stitches or to sew 1 – 2 cm reverse first.

- > Attach the Reverse pattern foot No. 1.



- > Touch the icon «Practical stitches».
 - The Straight stitch No. 1 is selected automatically.
- > Sew the seam up to where the zipper starts.
- > Sew the securing stitches.
- > Close the zipper length with long stitches.
- > Finish the seam allowances.
- > Iron the seam.
- > Open the zipper length.
- > Baste the zipper under the fabric so that the fabric folded edges meet over the center of the zipper.
- > Open the zipper a few centimeters.
- > Attach the Zipper foot No. 4.
- > Move the needle position to the right.
- > Use the Free Hand System to raise the presser foot and to position the sewing project.
- > Start sewing from top left.
- > Guide the foot so that the needle stitches along the zipper coils.
- > Stop in front of the zipper pull with needle position down.
- > Raise the presser foot.
- > Close the zipper.
- > Continue to sew and stop in front of the base of the zipper with needle position down.
- > Raise the presser foot and turn the sewing project.
- > Sew across the other side of the zipper and stop with needle position down.
- > Raise the presser foot and turn the sewing project.
- > Sew the second side from bottom to top.

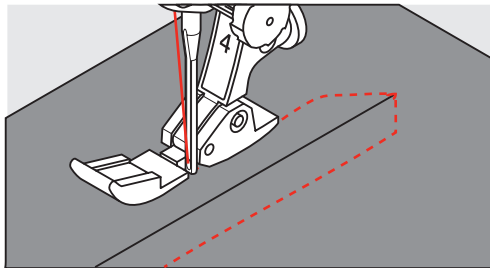

6.5 Sewing both sides of the zipper from bottom to top

It is recommended to sew in the zipper on both sides from bottom to top. This alternative is suitable for all the fabric with nap such as velvet.



When the fabric is densely woven or hard, it is recommended to use a needle with the size 90 – 100. This results in an even stitch formation.



- > Attach the Reverse pattern foot No. 1.
- > Touch the icon «Practical stitches».
 - The Straight stitch No. 1 is selected automatically.
- > Sew the seam up to where the zipper starts.
- > Sew the securing stitches.
- > Close the zipper length with long stitches.
- > Finish the seam allowances.
- > Iron the seam.
- > Open the zipper length.
- > Baste the zipper under the fabric so that the fabric folded edges meet over the center of the zipper.
- > Attach the Zipper foot No. 4.
- > Move the needle position to the right.
- > Use the Free Hand System to raise the presser foot and to position the sewing project.

- > Start sewing in the center of the seam at the end of the zipper.
- > Sew diagonally along the edge of the zipper coils.
- > Sew the first side (1) from bottom to top.
- > Stop in front of the zipper pull with needle position down.
- > Raise the presser foot.
- > Open the zipper as far as behind the presser foot.
- > Lower the presser foot and continue sewing.
- > Sew the second side (2) in exactly the same way from bottom to top.

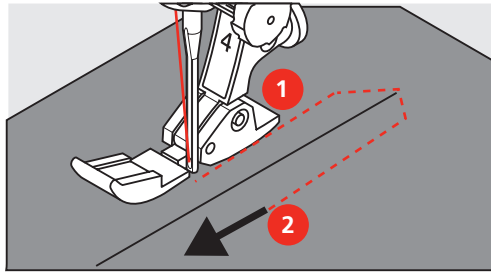

6.6 Sewing Triple Straight stitch

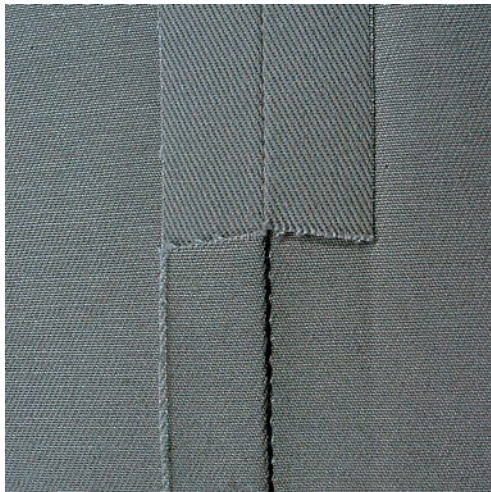

The Triple Straight stitch is especially suitable for durable seams and for firm, densely woven fabrics such as denim and corduroy. For firm or densely woven materials it is recommended to attach the Jeans foot No. 8. This will help to sew denim or canvas. For decorative topstitching the stitch length can be elongated.

- > Attach the Reverse pattern foot No. 1.
- > Touch the icon «Practical stitches».
- > Select the Triple Straight stitch No. 6.



6.7 Sewing Triple zig zag

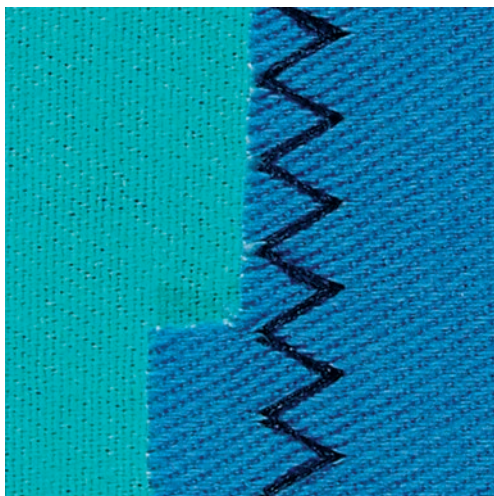

For firm fabrics, especially for denim, deckchair covers, awnings. Hems on items that need frequent washing. Finish the hem edges first.

- > Attach the Reverse pattern foot No. 1.
- > Touch the icon «Practical stitches».
- > Select the Triple zig zag No. 7.



6.8 Manual darning

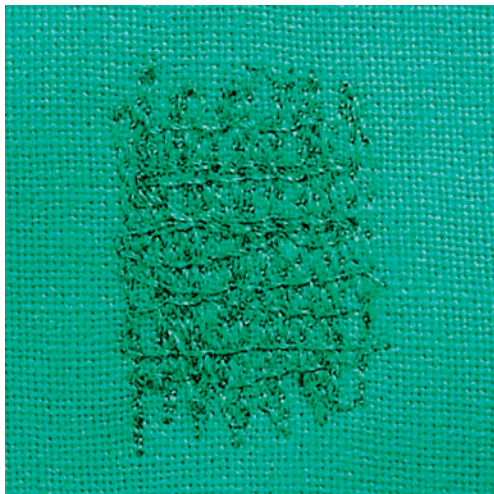

Used for darning holes or worn areas in all fabric types.

If the thread is lying on top and a poor stitch formation results, slow down the movement of the sewing project. If there are knots on the wrong side of the fabric, move the sewing project faster. When the thread breaks, guide the sewing project more consistently.

- > Attach the Darning foot No. 9 (optional accessory).
- > Touch the icon «Practical stitches».
 - The Straight stitch No. 1 is selected automatically.
- > Lower the feed dog.
- > Attach the slide-on table.
- > Hoop the sewing project in the round embroidery hoop (optional accessory).
 - The darning area stays evenly taut and cannot be distorted.



- > Sew from the left to the right, guide the fabric evenly by hand without using pressure.
- > Move in curves when changing the direction to avoid holes and thread breakage.
- > Work the rows in irregular lengths so that the thread is better spread over the fabric.

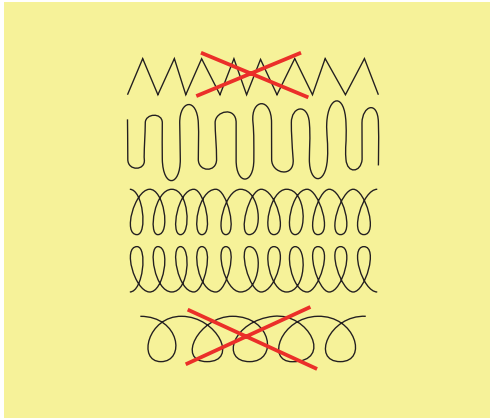

- > Sew the first rows not too close together and beyond the worn area.
- > Sew the rows in irregular lengths.

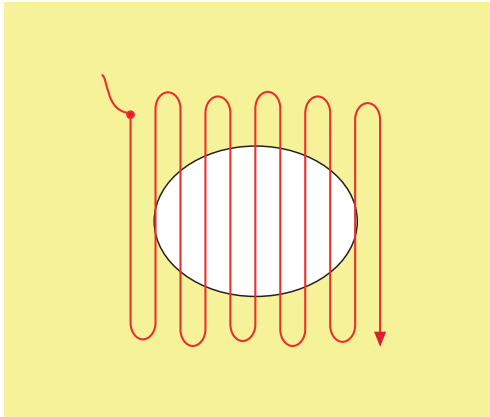

- > Turn the sewing project by 90°.
- > Sew the first rows not too close.

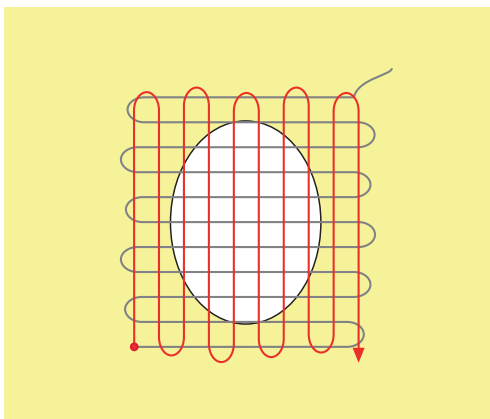

- > Turn the sewing project by 180°.

6.10 Reinforced darning, automatic

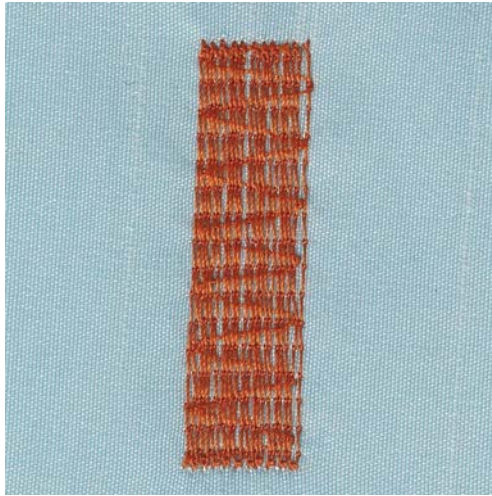

The reinforced Darning Program No. 23 is especially suitable for quick darning of worn or damaged areas. The reinforced Darning Program No. 23 replaces threads along the lengthwise grain in all materials.



If the Darning Program does not cover the whole worn or damaged area, it is recommended to reposition the work and sew the Darning Program again. The length is programmed and can be repeated as often as desired.

Via the direct entry length, a darning length up to 30 mm can be programmed.



- > Attach the Buttonhole foot No. 3A.
- > Touch the icon «Practical stitches».
- > Select the reinforced Darning Program No. 23.
- > Hoop light-weight materials in the round embroidery hoop (optional accessory).
 - The darning area stays evenly taut and cannot be distorted.
- > Start sewing top left.
- > Sew the first row.
- > Stop the machine.

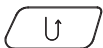

- > Push the button «Quick Reverse».
 - The length is programmed.
- > Finish sewing the Darning Program.
 - The machine stops automatically.

6.11 Finishing edges



The Zig zag No. 2 is suitable for all materials. It can also be used for elastic seams as well as for decorative sewing. Use darning thread for fine materials. When sewing satin stitch, it is recommended to select a dense, short the zig zag with a stitch length of 0.5 – 0.7 mm. The satin stitch can be used for appliqué and for embroidering.

Prerequisite:

- The edge of the fabric should lie flat and not roll.
- > Attach the Reverse pattern foot No. 1.
- > Touch the icon «Practical stitches».
- > Select the Zig zag No. 2 or the Satin stitch No. 1315.
- > Neither select too wide a stitch nor too long a stitch.
- > Guide the edge of the fabric into the center of the presser foot, so that the needle goes into the fabric on one side and over the edge into the air on the other side.



6.12 Sewing Double overlock



A double overlock seam is suitable for loose knitware and cross seams in knits. When working with knitware, a new jersey needle should be used to prevent damaging the delicate stitches. When sewing elastic materials, use a stretch needle.

- > Attach the Reverse pattern foot No. 1 or the Overlock foot No. 2.



- > Touch the icon «Practical stitches».
- > Select the Double overlock No. 10.

6.13 Narrow edgestitching



- > Attach the Blindstitch foot No. 5 or the Reverse pattern foot No. 1 or the Edge stitch foot No. 10 (optional accessory).
- > Touch the icon «Practical stitches».
 - The Straight stitch No. 1 is selected automatically.
- > Place the edge on the left against the guide of the Blindstitch foot.
- > Select the needle position left at the desired distance to the edge.

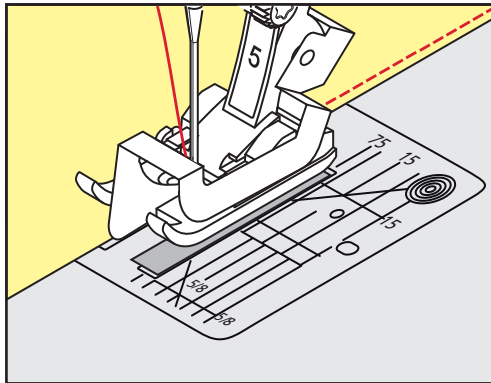

6.14 Wide edgestitching



- > Attach the Blindstitch foot No. 5 or the Reverse pattern foot No. 1 or the Edge stitch foot No. 10 (optional accessory).
- > Touch the icon «Practical stitches».
 - The Straight stitch No. 1 is selected automatically.
- > Guide the edge along the presser foot or along the marks at a distance of 1 – 2.5 cm (0.39 – 0.98 inch).
- > Select the needle position at the desired distance to the edge.

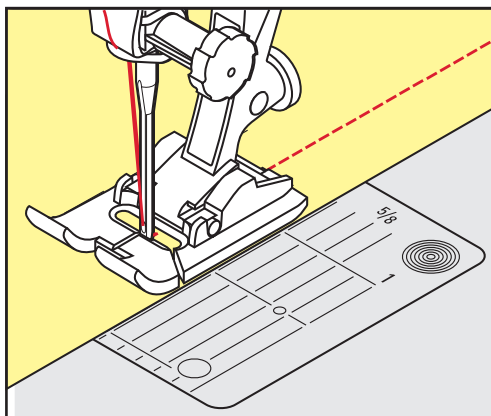

6.15 Edgestitching using the seam guide (optional accessory)

When sewing parallel wider lines, it is recommended to guide the seam guide (optional accessory) along a sewn line.

- > Attach the Reverse pattern foot No. 1 or the Edge stitch foot No. 10 (optional accessory).





- > Touch the icon «Practical stitches».
 - The Straight stitch No. 1 is selected automatically.
- > Loosen the screw on the back of the presser foot.
- > Insert the seam guide into the hole of the presser foot.
- > Adjust the width as desired.
- > Tighten the screw.
- > Guide the folded edge along the seam guide.

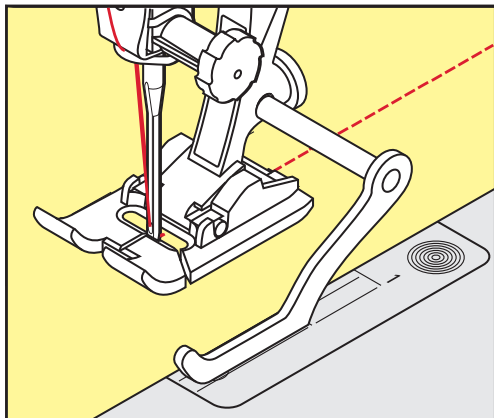

6.16 Sewing hem edges

When using the Blindstitch foot No. 5, it is recommended to select a needle position far left or far right. When using the Reverse pattern foot No. 1 or the Edge stitch foot No. 10 (optional accessory), all needle positions are possible.



- > Attach the Blindstitch foot No. 5 or the Reverse pattern foot No. 1 or the Edge stitch foot No. 10 (optional accessory).
- > Touch the icon «Practical stitches».
 - The Straight stitch No. 1 is selected automatically.
- > Place the inside upper edge right against the guide of the Blindstitch foot.
- > Select the needle position far right to sew along the upper edge.

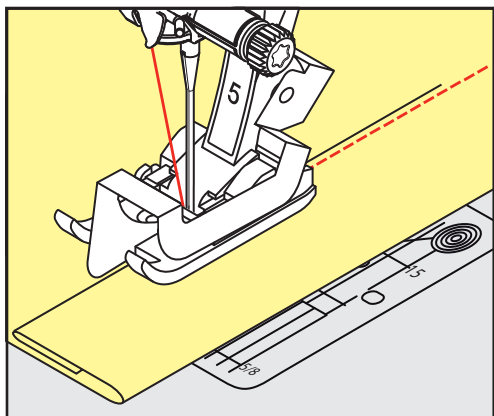

6.17 Sewing blind hems

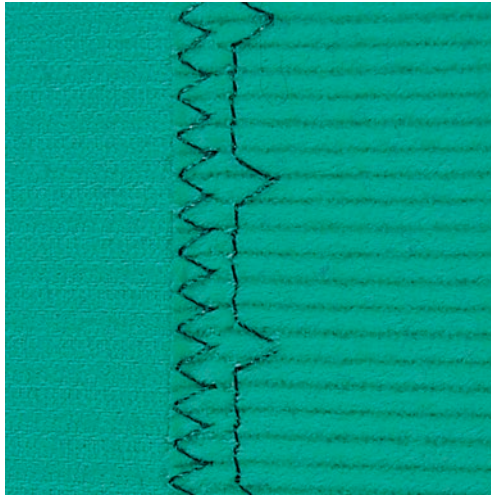

For invisible hems in medium to heavy-weight cotton, wool and blended materials.

Prerequisite:

- The fabric edges are finished.
- > Attach the Blindstitch foot No. 5.
- > Touch the icon «Practical stitches».
- > Select the Blindstitch No. 9.
- > Fold the fabric back over the right side of the fabric to expose the finished lower edge.
- > Place the fabric under the presser foot and move the folded edge against the metal guide on the presser foot.
- > Guide the folded edge evenly along the metal guide of the foot to sew the stitches evenly deep.
 - Make sure that the needle only pierces the edge of the fold.
- > After sewing about 10 cm (ca. 3.93 inch) check both sides of the fabric and adjust the width again if necessary.

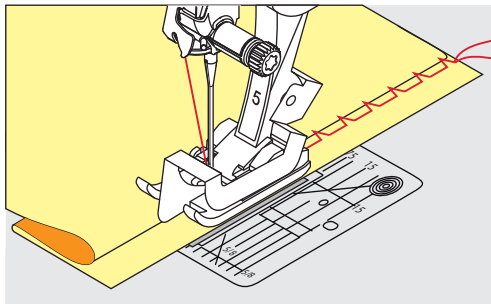

6.18 Sewing visible hems

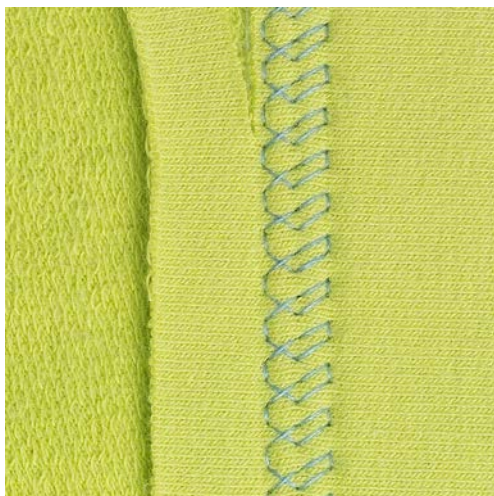

The visible hem is especially suitable for elastic hems in jersey, cotton, wool, synthetic and blended materials.



- > Attach the Reverse pattern foot No. 1.
- > Touch the icon «Practical stitches».
- > Select Tricot stitch No. 14.
- > Iron the hem and baste if necessary.
- > Reduce the presser foot pressure if necessary.
- > Sew the hem at the preferred depth on the right side.
- > Trim the excess fabric from the wrong side.

6.19 Sewing flat joining seams

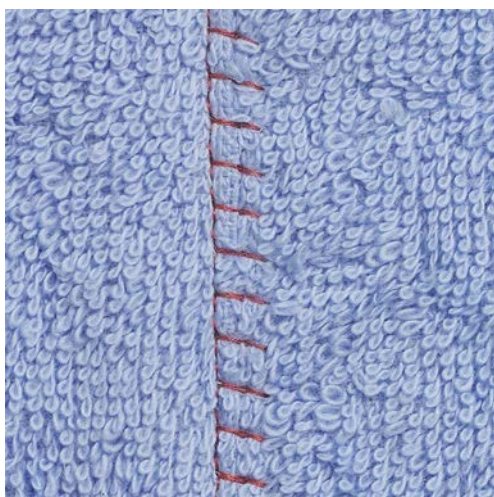

The flat joining seam is especially suitable for long-pile or thick materials such as terry cloth, felt or leather.



- > Attach the Reverse pattern foot No. 1.
- > Touch the icon «Practical stitches».
- > Select the Stretch overlock No. 13.
- > Overlap the fabric edges.
- > Sew along the fabric edge.
- > The needle must stitch over the edge of the top layer on the right into the bottom layer to get a very flat durable seam.

6.20 Sewing basting stitches

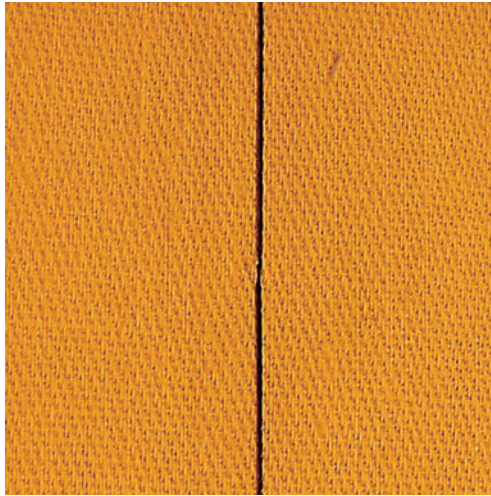

For basting it is recommended to use a thin darning thread. It can be removed easily. The basting stitch is suitable for work where a large stitch length is desired.

- > Attach the Darning foot No. 9 (optional accessory).
- > Lower the feed dog.
- > Touch the icon «Practical stitches».
- > Select the Basting stitch No. 30.
- > Pin the fabric layers at a right angle to basting direction to prevent the layers from slipping.
- > Hold the threads and sew 3 – 4 securing stitches at the beginning.
- > Sew a stitch and pull the fabric back at the desired stitch length.
- > Sew a stitch.
- > At the end sew 3 – 4 securing stitches.



7 Decorative stitches





7.1 Overview Decorative Stitches

Depending on the type of material, simple or more complex decorative stitches should be selected to best suit the material.

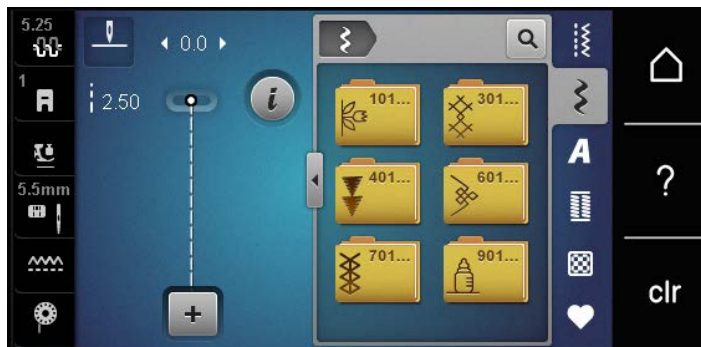
- Decorative stitches which are programmed with simple straight stitches are particularly appropriate for light-weight materials, e.g. the Decorative stitch No. 101.
- Decorative stitches which are programmed with triple straight stitches or with a few satin stitches are particularly appropriate for medium-weight materials, e.g. Decorative stitch No. 107.
- Decorative stitches which are programmed with satin stitches are particularly appropriate for heavyweight materials, e.g. Decorative stitch No. 401.

For a perfect stitch formation it is of advantage to use the same thread color for upper and bobbin thread and a stabilizer. With pile or longfiber materials it is recommended to use an additional, water-soluble stabilizer on the right side which can be easily removed after sewing.



Decorative stitch	Category	Name
	Category 100	Natural stitches
	Category 300	Cross stitches
	Category 400	Satin stitches
	Category 600	Ornamental stitches
	Category 700	Heirloom stitches
	Category 900	Children stitches

7.2 Bobbin-Play

NOTICE

Inappropriate bobbin case is used

Damage of the bobbin case.

> Use the Bobbinwork bobbin (optional accessory).

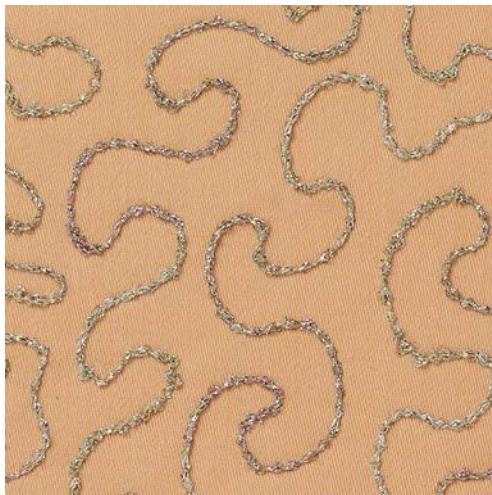

The bobbin can be filled with different thread material. For free-motion stitching to add texture. This method is similar to free-motion sewing, but is done on the **wrong** side of the fabric.

The area to be sewn should be reinforced with embroidery stabilizer. The design can be drawn on the wrong side of the fabric. You can also draw the design on the front side of the fabric. The lines can be followed with a freely guided straight stitch using polyester, cotton or rayon thread. The rows of stitching are visible on the wrong side of the fabric and serve as reference lines for the bobbin-thread sewing.

Bobbin-thread sewing can be done using the BSR function. It is recommended to guide your project at consistent speed evenly under the needle, following the lines of the design. The stabilizer must be removed after sewing.

First sew a sample to check what the result looks like on the wrong side of the fabric.

Not all decorative stitches are suitable for this technique. Using simple decorative stitches provide the best results. Avoid compact stitch types and beads of buttonholes.

- > Attach the Embroidery foot No. 20 (optional accessory).
- > Touch the icon «Decorative stitches».
- > Select the appropriate decorative stitch.
- > Turn the «Upper Multifunction knob» and the «Lower Multifunction knob» to adjust the stitch length and the stitch width so that a nice stitch formation can be achieved even when using thick thread.
- > Touch the icon «Upper thread tension» and adjust the upper thread tension if necessary.



7.3 Sewing cross stitches

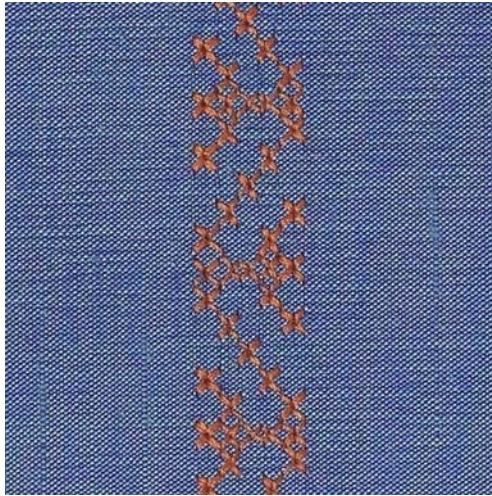

Cross stitch embroidery is a traditional technique and a charming addition to the other decorative stitches. If the cross stitches are sewn on a fabric with a linen texture, they look like hand-stitched cross stitching. When cross stitches are sewn with embroidery yarn, the stitch pattern appears fuller. Cross stitches are particularly used for home furnishing, trimmings on garments and embellishing in general. As every following line refers to the first row, it is important to stitch the first row in a straight line.

- > Attach the Reverse pattern foot No. 1 or the Open Embroidery foot No. 20 (optional accessory).
- > Select a cross stitch of the Category 300 and combine it as desired.
- > Stitch the first row using the seam guide or slide-on table seam guide to sew a straight line.
- > Stitch the second row next to the first at a distance of one presser foot's width or using the seam guide.





7.4 Pintucks

Pintucks

This technique reduces the size of the fabric. This means that always enough fabric should be calculated. Pintucks are narrow stitched folds which are normally sewn on the fabric before cutting out the pieces for garments or other sewing projects. They are suitable for embellishing or in combination with other heirloom embroidery techniques.

A more distinctive and relief-like effect can be achieved when the pintucks are corded, which means that they are sewn with an additional pintuck cord. Choose a pintuck cord that fits well into the grooves of the selected pintuck foot. The cord must be colorfast and shrink-proof.

Overview pintucks

Pintuck foot	Number	Description
	30 (optional accessory) 3 grooves	4 mm double needle: for heavy fabrics.
	31 (optional accessory) 5 grooves	3 mm double needle: for heavy to medium-weight fabrics.
	32 (optional accessory) 7 grooves	2 mm double needle: for light to medium-weight fabrics.
	33 (optional accessory) 9 grooves	1 or 1.6 mm double needle: for very light fabrics (without pintuck cord).

Inserting the cord

- > Switch the machine off and disconnect it from the power supply system.
- > Remove the needle.
- > Remove the presser foot.
- > Remove the stitch plate.
- > Open the bobbin cover.
- > Pull the cord through the hook opening from the bottom and through the opening of the stitch plate.
- > Replace the stitch plate.
- > Close the bobbin cover.
- > Make sure that the cord slides through the little thread slot of the bobbin cover.

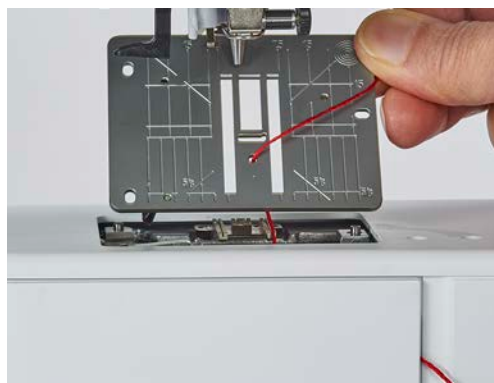

8 Alphabets

8.1 Overview Alphabet

Block, Double block and Script alphabets as well as as Cyrillic can also be sewn in lower case letters.

For a perfect stitch formation use the same thread color for upper and bobbin threads. The fabric can be reinforced with embroidery stabilizer on the wrong side. When working with pile or napped fabrics, e.g. toweling, use an additional, water-soluble stabilizer on the right side of the fabric.

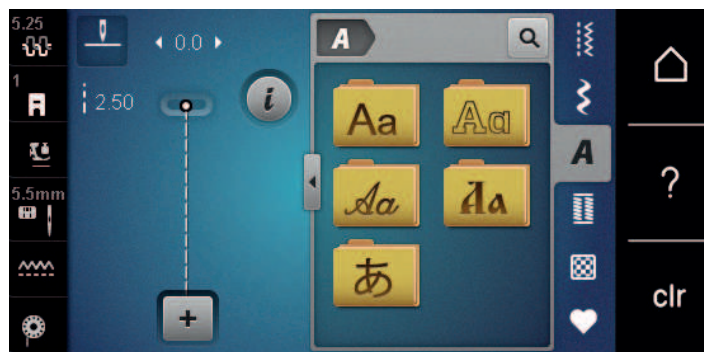

Stitch patterns	Name
ABCabc	Block alphabet
ABCabc	Double-Block
<i>ABCabc</i>	Script (Italics)
АБВабв	Cyrillic
あいう	Hiragana

8.2 Creating lettering



It is recommend to sew a test sample using the desired thread, the original fabric and the original stabilizer. Please make sure that the fabric is fed evenly and lightly without colloding and being caught. Do not pull, push or hold the fabric while sewing.



- > Touch the icon «Alphabets».
- > Select the font.



- > Touch the icon «Single/Combi mode» to create a combination.

- > Touch the icon «Display alphabets» (1) to open an extended enter mode.



- > Select the letters.
- > Touch the icon (2) (standard setting) to use upper case letters.
- > Touch the icon (3) to use lower case letters.
- > Touch the icon (4) to use figures.
- > Touch the icon (5) to use special characters and mathematical symbols.











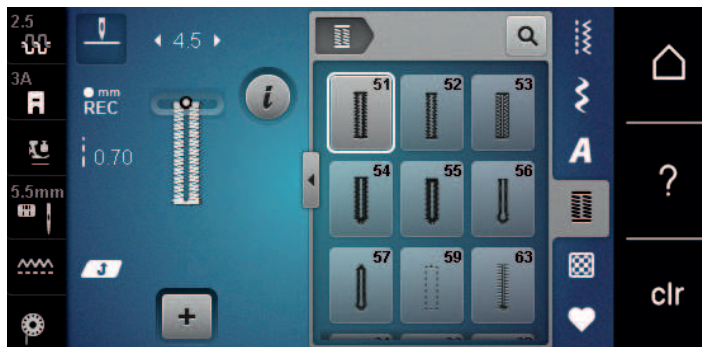

- > Touch the icon «DEL» to delete single letters of the entered text.
- > Touch the icon «Display alphabets» again to close the extended enter mode.

9 Buttonholes

9.1 Overview Buttonholes

To create the correct buttonhole for every button, every purpose and for every garment, your BERNINA 485 is equipped with a considerable collection of buttonholes. The corresponding button can be sewn on automatically. Eyelets can also be sewn.



Buttonhole	Buttonhole number	Name	Description
	51	Standard buttonhole	For light to medium-weight fabrics; blouses, dresses, bedlinens.
	52	Standard buttonhole narrow	For light to medium-weight fabrics; blouses, dresses, children's and baby clothes, crafts.
	53	Stretch buttonhole	For any highly elastic jersey made from cotton, wool, silk and synthetic fibers.
	54	Round buttonhole with normal bartack	For medium to heavy-weight fabrics; dresses, jackets, coats, rainwear.
	55	Round Buttonhole with horizontal bartack	For medium to heavy-weight fabrics: dresses, jackets, coats, rainwear.
	56	Keyhole buttonhole	For heavy-weight, non-stretch fabrics; jackets, coats, leisure wear.
	57	Keyhole buttonhole with pointed bartack	For firm, non-stretch fabrics: jackets, coats, leisure wear.
	59	Straight stitch buttonhole	Program for staystitching buttonholes, for pocket openings, reinforcing buttonholes, especially for buttonholes in leather and imitation leather.
	63	Heirloom	For light to medium-weight woven fabrics; blouses, dresses, leisure wear, bedlinens.

9.4 Marking buttonholes

- > For the buttonholes to be sewn manually, mark the position and the length on the fabric using chalk or a water-soluble pen.

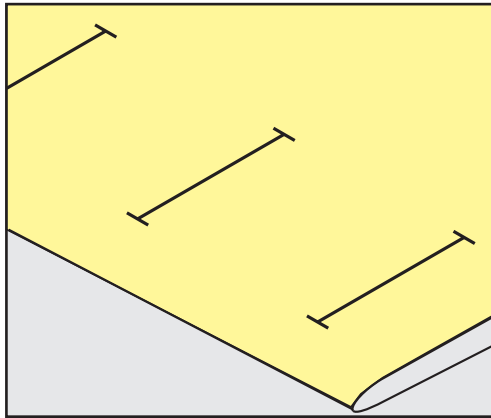

- > For the buttonholes to be sewn automatically, mark the complete length of 1 buttonhole on the fabric using chalk or a water-soluble pen. For any subsequent buttonholes mark the starting point.

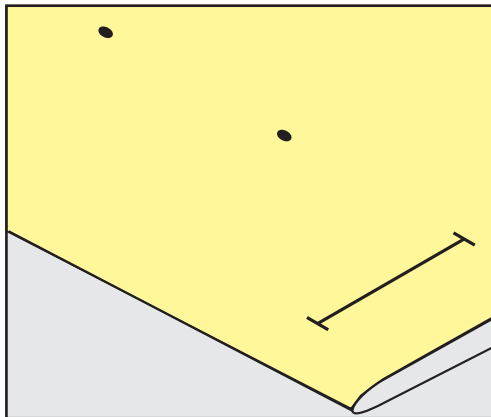

- > For keyhole and round buttonholes mark the length of the bead with chalk or a water-soluble pen on the fabric. For any subsequent buttonholes mark the starting point. The length of the keyhole is sewn additionally.

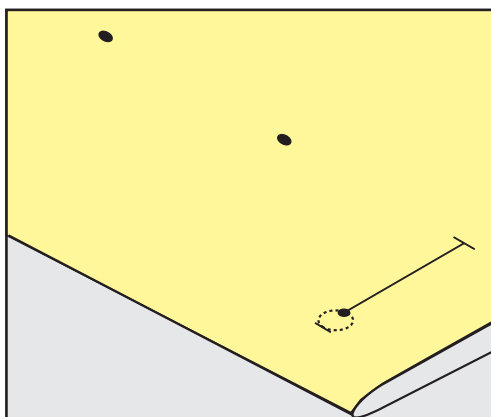

9.5 Cord

Using cord with the Buttonhole foot with slide No. 3A

The cord reinforces and enhances the buttonhole and is particularly suitable for the Buttonhole No. 51. Optimal cord is Perle cotton No. 8, strong hand-sewing thread and fine crochet yarn. It is recommended not to hold the cord when sewing.

Prerequisite:

- The Buttonhole foot with slide No. 3A is attached and raised.
- > Insert the needle at the beginning of the buttonhole.
- > Guide the cord on the right side under the buttonhole foot.
- > Hook the cord over the pin at the back of the buttonhole foot.

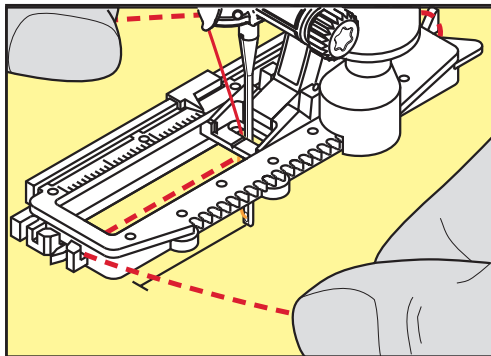

- > Pull the cord on the left side under the buttonhole foot to the front.

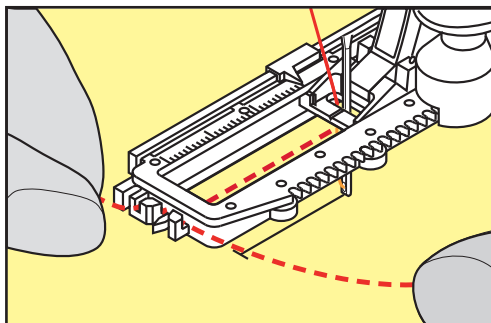

- > Pull the cord ends into the slits.
- > Lower the buttonhole foot.
- > Sew the buttonhole in the usual manner.
- > Pull the cord through the buttonhole until the loop disappears in the bartack.

- > Pull the ends of the cord through to the wrong side of the fabric (using a hand stitching-needle), knot or secure with stitches.

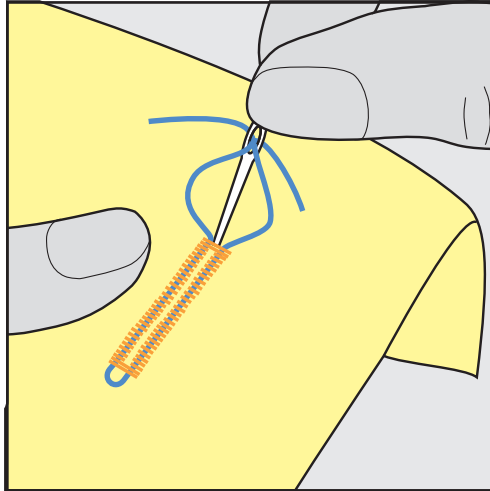

Using cord with the Buttonhole foot No. 3 (optional accessory)

Prerequisite:

- The Buttonhole foot No. 3 is attached and raised.
- > Insert the needle at the beginning of the buttonhole.
- > Hook the cord over the pin at the front of the buttonhole foot.

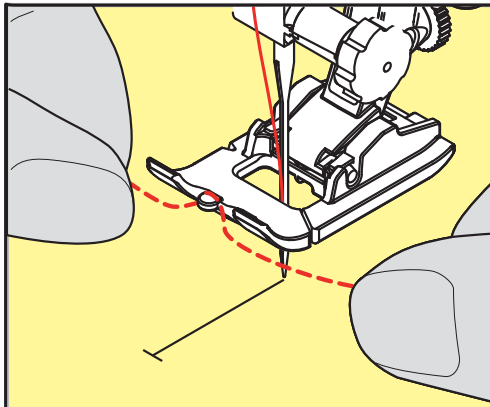

- > Pull both cord ends under the buttonhole foot to the back and insert each a cord into the slits of the sole.

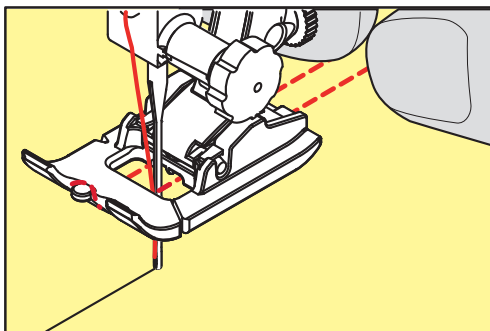

- > Lower the buttonhole foot.
- > Sew the buttonhole in the usual manner.
- > Pull the cord through the buttonhole until the loop disappears in the bartack.



- > Pull the ends of the cord through to the wrong side of the fabric (using a hand stitching-needle), knot or secure with stitches.

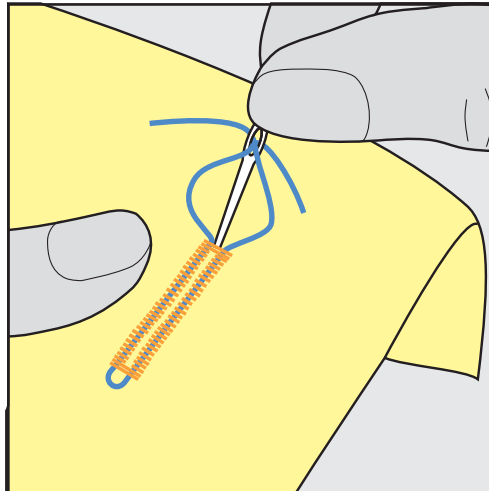

9.6 Sewing a test sample

Always sew a test sample of the buttonhole on the same fabric: It is recommended to use the same stabilizer and to select the same buttonhole. The test sample should also be sewn in the respective direction. By sewing a test sample the settings can be adjusted until the sewing result is satisfying.

When working with soft loosely woven materials or for buttonholes which are highly stressed, it is worth underlaying the buttonholes with the Straight stitch buttonhole No. 59. This is also recommended to reinforce buttonholes in leather, vinyl or felt.

Alterations of the balance when sewing a manual standard buttonhole as well as the keyhole and the round buttonhole affect both beads in the same way. With the manual keyhole or round buttonhole the alterations affect both sides differently.

If the stitch counter function is used and alterations are made concerning the balance, the alterations affect both buttonhole beads differently.



- > Touch the icon «Buttonholes».
- > Select the buttonhole.
- > Select and attach the desired presser foot.
- > Place the fabric under the presser foot and lower the presser foot.
- > Press the foot control carefully and start sewing. Guide the fabric slightly.
- > Check the balance while sewing and adjust if necessary.
- > Check the test sample and make further amendments if necessary.

9.7 Determining the buttonhole slit width

The width of the buttonhole slit can be adjusted between 0.1 – 2.0 mm before sewing.



- > Touch the icon «Buttonholes».
- > Select the buttonhole.



- > Touch the icon «i»-Dialog.

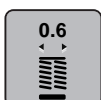

- > Touch the icon «Buttonhole slit width».
- > Turn the «Upper Multifunctional knob» or the «Lower Multifunctional knob» to adjust the buttonhole slit width as desired.

9.8 Determining the buttonhole length with the Buttonhole foot with slide No. 3A



The button can be centered in the yellow circle on the display. By turning the «Upper/Lower Multifunction knobs», the yellow circle can be enlarged or downsized to determine the diameter of the button.

Additionally to the diameter of the button, 2 mm are added automatically for the buttonhole length. If the diameter of the button is 14 mm, the buttonhole length is calculated 16 mm.

Prerequisite:

- The Buttonhole foot with slide No. 3A is attached.



- > Touch the icon «Buttonholes».
- > Select the buttonhole.



- > Touch the icon «i»-Dialog.

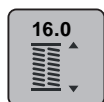

- > Touch the icon «Adjust the buttonhole length».
- > Turn the «Upper Multifunction knob» or the «Lower Multifunction knob» to adjust the buttonhole length.

9.9 Determining the buttonhole length with the Buttonhole foot No. 3

With the Buttonhole foot No. 3, the length of the buttonhole must be determined via the stitch counter function. The stitch counter function is suitable for all types of buttonholes. The left buttonhole bead is sewn forward, the right buttonhole bead is sewn in reverse. If alterations of the balance are made, the stitch counter function has to be saved for every buttonhole separately.

Prerequisite:

- The Buttonhole foot No. 3 is attached.



- > Touch the icon «Buttonholes».
- > Select the buttonhole.



- > Touch the icon «i»-Dialog.



- > Touch the icon «Program the length with the stitch counter».
- > Sew the desired buttonhole length.
- > Stop the machine.

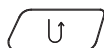

- > Push the button «Quick reverse» so that the machine sews the lower bartack and the second bead in reverse.
- > Stop the machine at the height of the first stitch.
- > Push the button «Quick Reverse» again so that the machine sews the upper bartack and the securing stitches.
 - The length of the buttonhole remains saved and every subsequent buttonhole is sewn identically until the machine is switched off.

9.10 Sewing a buttonhole automatically with the Buttonhole foot with slide No. 3A

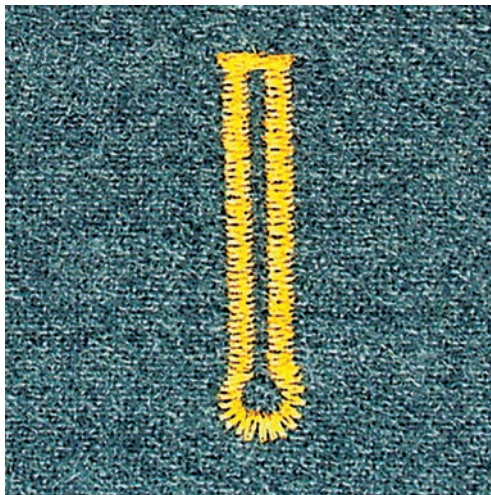
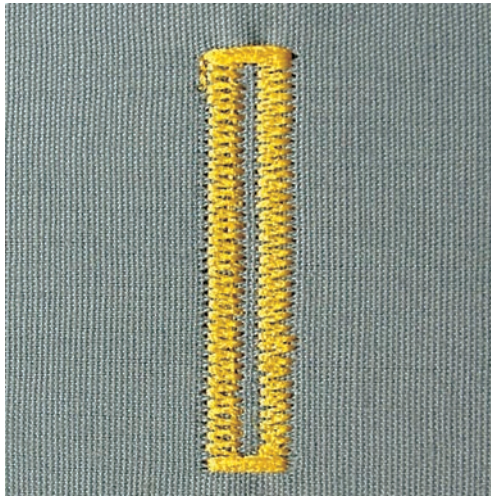

NOTICE! It depends on the markets, whether or not the Buttonhole foot with slide No. 3A is included in the delivery contents. When the Buttonhole foot with slide No. 3A is not included in the standard accessory, it can be purchased as optional accessory at the specialized BERNINA retailers.

When the Buttonhole foot with slide No. 3A is used, the length of the buttonhole is measured automatically by the lens on the presser foot. The buttonhole will be exactly duplicated and the machine switches to the next step automatically when the maximum length is reached. The Buttonhole foot with slide No. 3A is suitable for buttonholes at a length of 4 – 31 mm, depending on the buttonhole type. The slide of the Buttonhole foot must lie perfectly flat on the fabric so that the length can be measured accurately. Programmed buttonholes are the same length and of the same nice look.

Prerequisite:

- The Buttonhole foot with slide No. 3A is attached.



- > Touch the icon «Buttonholes».
- > Select buttonhole No. 51 – 57, No. 59 or 63.
- > Sew the desired buttonhole length.

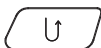

- > Push the button «Quick Reverse» to program the length.



- > Push the button «Start/Stop» or press the foot control.
 - The machine finishes the buttonhole automatically. All subsequent buttonholes are sewn at the same length.

9.11 Sewing the manual 7-step buttonhole

The length of the buttonhole is determined manually while sewing. Bartack, eye and securing stitches are preprogrammed. The individual steps can also be selected by scrolling using the arrow icons or by touching the button «Quick Reverse».

Prerequisite:

- The Buttonhole foot No. 3 (optional accessory) is attached.



- > Touch the icon «Buttonholes».
- > Select the Buttonhole No. 51.



- > Touch the icon «i»-Dialog.



- > Touch the icon «Adjust the length manually».
 - Step 1 in the display is activated for the buttonhole start.

- > Sew the desired buttonhole length.
 - As soon as sewing is started, step 2 is activated.

- > Stop the machine at desired length of the buttonhole or at the end of the length marking.



- > Touch the icon «Scroll down» so that step 3 appears.
 - The machine sews straight stitches in reverse.

- > Stop the machine at the height of the first stitch where the buttonhole starts.

- > Touch the icon «Scroll down» so that step 4 appears.
 - The machine sews the upper bartack and stops automatically.

- > Touch the icon «Scroll down» so that step 5 appears.
 - The machine sews the second bead.

- > Stop the machine at the height of the last stitch of the first bead.

- > Touch the icon «Scroll down» so that step 6 appears.
 - The machine sews the lower bartack and stops automatically.

- > Touch the icon «Scroll down» so that step 7 appears.



- The machine secures and stops automatically.

9.12 Sewing the manual 5-step buttonhole

The length of the buttonhole is determined manually while sewing. Bartack, eye and securing stitches are preprogrammed. The individual steps can also be selected by scrolling using the arrow icons or by touching the button «Quick Reverse».

Prerequisite:

- The Buttonhole foot No. 3 (optional accessory) is attached.



- > Touch the icon «Buttonholes».
- > Select the Buttonhole No. 54.



- > Touch the icon «i»-Dialog.



- > Touch the icon «Adjust the length manually».
 - Step 1 the display is activated for the buttonhole start.
- > Sew the desired buttonhole length.
 - Step 2 is activated.



- > Stop sewing at the desired length of the bead or at the marking.
- > Touch the icon «Scroll down» so that step 3 appears.
- > The machine sews the eye or the keyhole and stops automatically.
- > Touch the icon «Scroll down» so that step 4 appears.
 - The machine sews the second bead in reverse.
- > Stop the machine at the first stitch where the buttonhole starts.
- > Touch the icon «Scroll down» so that step 5 appears.



- The machine sews the upper bartack and secures automatically.

9.13 Cutting the buttonhole open with the seam ripper

- > Place a pin in each end of the buttonhole to avoid accidental cutting into ends of buttonhole.
- > Cut the buttonhole from both ends to the middle.

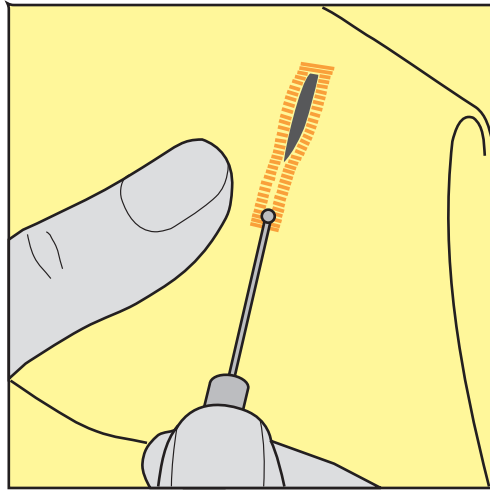

9.14 Cutting open buttonholes with the buttonhole cutter (optional accessory)

- > Place the fabric on an appropriate piece of wood.

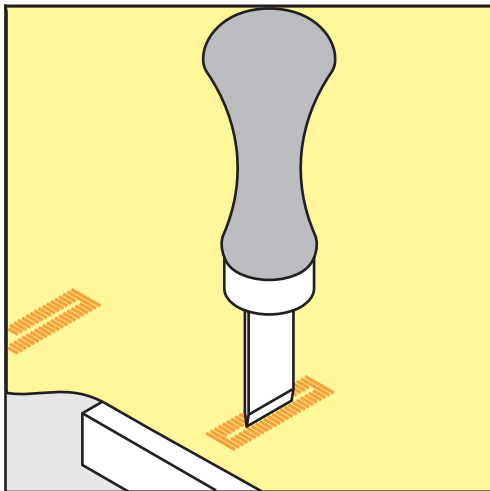

- > Position the cutter in the center of the buttonhole.
- > Press down on the cutter with your hand.

9.15 Sewing on buttons

With the Button sew-on Program buttons with 2 or 4 holes can be sewn on. To reinforce the stability the Button sew-on Program can be sewn twice. When sewing on a button with 4 holes, the front holes should be sewn first.

Buttons sewn on for decorative purposes only are stitched without a thread shank. The shank height is the distance between the button and the fabric. When using the Button sew-on foot No. 18 (optional accessory), the shank height can be adjusted with the screw.

With the Button sew-on Program the first securing stitch is always stitched into the left hole of the button.

Prerequisite:

- The Darning foot No. 9 (optional accessory) or the Button sew-on foot No. 18 (optional accessory) is attached.



- > Touch the icon «Buttonholes».
- > Lower the feed dog.
- > Select the Button sew-on Program No. 60.
- > Place the button on the sewing project.
- > Turn the handwheel to adjust the distance between the holes.
- > Hold the threads when starting to sew and, if necessary, alter the stitch width.
 - The machine sews the Button sew-on Program and stops automatically.
- > Pull on both bobbin threads until the ends of the upper threads are visible on the wrong side.
- > Knot the ends manually.

9.16 Sewing eyelets



For increased stability sew the eyelet twice.

Prerequisite:

- The Reverse pattern foot No. 1 or the Open embroidery foot No. 20 (optional accessory) is attached.



- > Touch the icon «Buttonholes».
- > Select the Eyelet Program No. 61 or No. 62.
- > Turn the «Upper Multifunction knob» or the «Lower Multifunction knob» to alter the size of the eyelet.
- > Sew the Eyelet Program.
 - The machine stops automatically at the end of the Eyelet Program.
- > Use an awl, punch pliers or a hole punch to open the eyelet.

10 Quilting

10.1 Overview Quilt Stitches

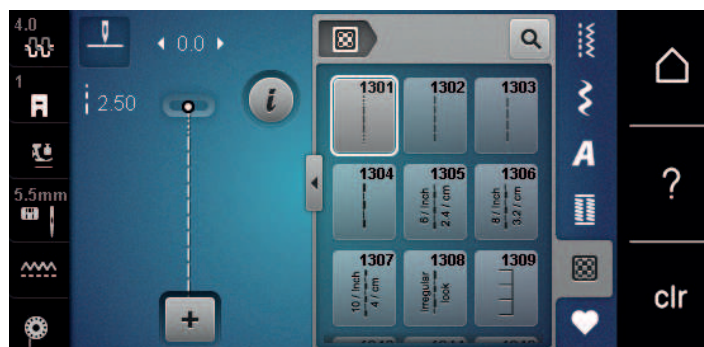

Stitch patterns	Stitch number	Name	Description
	1301	Quilting, Securing Program	To secure at the sewing start and sewing end with short stitches forward.
	1302	Quilting straight stitch	Straight stitch at 3 mm stitch length.
	1303	Piecing stitch/Straight stitch	Straight stitch at 2 mm stitch length.
	1304	Handlook quilt stitch 1304 – 1308	Imitation of handlook quilt stitch with monofilament.
	1309	Blanket stitch 1309 – 1310, 1313 – 1314	For appliqué and sewing on ribbons.
	1311	Dekorative Quilt stitches 1311, 1317 – 1324	Imitation of handlook quilt stitch with monofilament.
	1315	Satin stitch	For appliqué.
	1316	Blindstitch narrow	To sew blind stitches.
	1331	Stippling stitch	Imitation of stipple quilting.
	1332	Feather stitch	For "Crazy Patchwork" and embellishing.
	1333	Feather stitch variations	For "Crazy Patchwork" and embellishing.
	1334	Feather stitch variations	For "Crazy Patchwork" and embellishing.

10.2 Quilting, Securing Program

Prerequisite:

- The Reverse pattern foot No. 1 is attached.



- > Touch the icon «Quilt stitches».
- > Select Quilt stitch pattern No. 1301.
- > Press the foot control.
 - The machine sews 6 stitches forward automatically when sewing is started.
- > Sew the seam in the desired length.

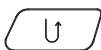

- > Push the button «Quick reverse».
 - The machine sews 6 stitches forward automatically and stops automatically at the end of the Securing Program.

10.3 Sewing handlook quilt stitches

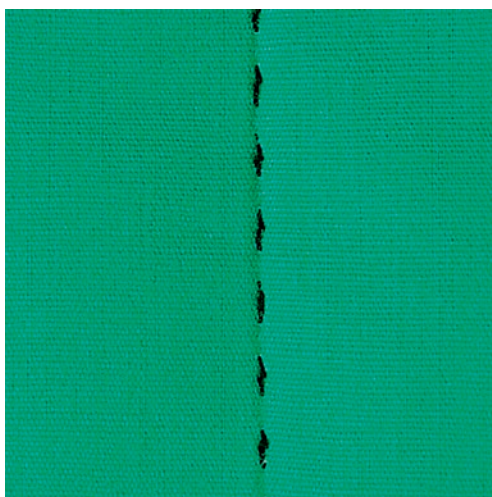

Handlook quilt stitches are suitable for all fabrics and sewing projects which should look hand sewn. It is recommended to use a monofilament thread as upper thread and an embroidery thread as bobbin thread. The sewing speed should be moderate to prevent the monofilament from breaking. If required, the upper thread tension and the balance can be adjusted to the sewing project and the desired quilt stitch.

Prerequisite:

- The Reverse pattern foot No. 1 is attached.



- > Touch the icon «Quilt stitches».
- > Select Handlook quilt stitches No. 1304 or 1305, 1306, 1307 or 1308.
- > If required, adjust the upper thread tension and the balance to the sewing project and the desired quilt stitch.
- > Press the foot control or the button «Start/Stop» to start the machine.

10.4 Guiding the quilt work freely



Quilt gloves with rubber fingertips (optional accessory) will help when guiding the fabric.

It is recommended to use the slide-on table and the Free Hand System. With free-motion quilting, it is of advantage to quilt from the center outwards and to guide the fabric using smooth, round movements to form the design of your choice. Free-motion quilting and darning are based on the same free-motion principles.

With stipple quilting, entire surfaces of the fabric are filled with quilt stitches. The single lines of stitching are rounded and never cross one another.

Prerequisite:

- The top layer, the batting and the backing are pinned together or basted.
- The feed dog is lowered.
- The Darning foot No. 9 (optional accessory) is attached.



- > Touch the icon «Practical stitches».
 - The Straight stitch No. 1 is selected automatically.
- > Adjust the upper thread tension and the balance to the sewing project if necessary.
- > Press the foot control or the button «Start/Stop» to start the machine.
- > Hold both hands close to the presser foot like an embroidery hoop to guide the fabric.
- > If the thread is lying on top of the fabric, slow down the movement.
- > If there are knots on the wrong side of the fabric, move the fabric more quickly.

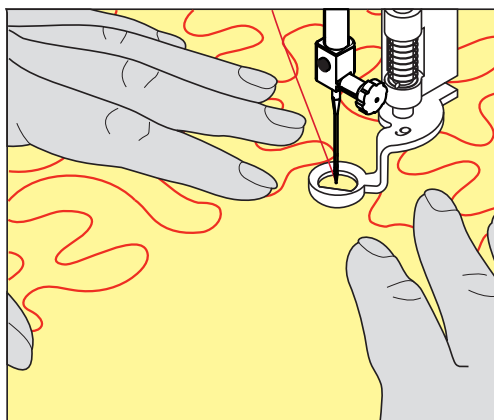

11 BERNINA Stitch Regulator (BSR) (optional accessory)

The BERNINA Stitch regulator equalizes the stitch length which results of the free movement of the fabric while free-motion sewing - a sewing technique which grows more and more popular. When free-motion sewing with the BSR presser foot, every stitch is equally long and the stitch formation is perfectly regular.

As soon as the BSR presser foot is attached and the feed dog is lowered, the selection menu of the desired mode appears in the display of the machine. The BSR presser foot can be used with sewing straight stitch as well as zig zag.

The BSR presser foot reacts on the movement of the fabric and therefore controls the speed of the machine up to the highest possible speed. It can be said: the faster the movement of the material, the higher the speed of the machine.

If the fabric is moved too quickly, an acoustic signal sounds. The beeper can be activated or deactivated in the BSR display. The sound of the beeper can also be activated or deactivated in the Setup Program.

11.1 BSR mode 1

The BSR function can be controlled via the foot control or with the button «Start/Stop». Start the BSR mode. At the BSR presser foot a red light is on. By moving the fabric the machine accelerates. If the fabric isn't moved, securing in place is possible without pressing an additional button. When working via the foot control or when using the button «Start/Stop», the BSR mode doesn't stop automatically.

11.2 BSR mode 2

The BSR function can be controlled via the foot control or the button «Start/Stop». The machine starts only when the foot control or the button «Start/Stop» is pressed and the fabric is moved simultaneously. Without moving the fabric, the BSR2 modus stops after about 7 seconds. The red light goes off (only when working with the button «Start/Stop»). When working via the foot control, the red light doesn't go off.

11.3 BSR function with Straight stitch No. 1

This function allows free-motion quilting with straight stitch and a pre-programmed stitch length up to 4 mm. The programmed stitch length is maintained within a certain speed, independent of the fabric movement.

11.4 BSR function with Zig zag No. 2

The zig zag can be used e.g. for thread painting. The set stitch length will **not** be maintained when sewing the zig zag stitch, but the BSR function simplifies the application.

11.5 Sewing preparations for quilting

Attach the BSR presser foot

NOTICE

The lens of the BSR presser foot is dirty

The machine doesn't recognize the BSR presser foot.

> Clean the lens with a soft, slightly damp cloth.

> Change the presser foot.

- > Insert the cable of the BSR foot into the connection (1). The BSR plug must be inserted vertically.



- > Switch the machine on.
 - The BSR display opens and the BSR 1 mode is activated.

Changing the presser foot sole

NOTICE

The lens of the BSR presser foot is dirty

The machine doesn't recognize the BSR presser foot.

- > Clean the lens with a soft, slightly damp cloth.

The standard stitch length is 2 mm. When sewing small shapes and stippling it is recommended to shorten the stitch length to 1 – 1.5 mm.

- > Raise the needle.
- > Raise the BSR foot.
- > Switch the machine off and disconnect it from the power supply system.
- > Remove the BSR foot from the machine.
- > Press both push buttons at the BSR foot against each other.

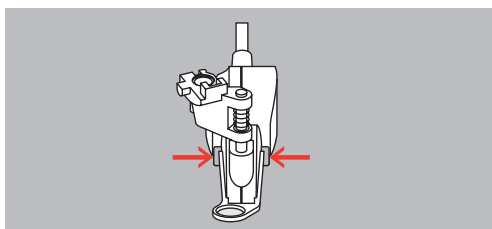

- > Pull the presser foot sole out of the guide downwards.
- > Insert the new presser foot sole into the guide and push upwards until it clicks into place.
- > Attach the BSR presser foot.

11.6 Using the BSR mode

The BSR function can be controlled via the foot control or the button «Start/Stop».

Starting via the foot control: The foot control needs to be pressed while quilting. The machine keeps running in the BSR1 mode until the foot control is released, even if the fabric isn't moved.

If quilting is stopped in the BSR2 mode, the machine sews another stitch depending on the needle position and stops with needle position up.

Prerequisite:

- The slide-on table is attached.
- The knee lifter of the Free Hand System is attached.
- > Lower the feed dog.
- > Select the desired BSR mode.
- > Lower the presser foot.



- > Push the button «Start/Stop» or press the foot control and keep it pressed to start the BSR mode.
 - At the BSR foot a red light is on.



- > Move the fabric to control the speed of the machine in the BSR mode.
- > Push the button «Start/Stop» again or release the foot control to stop the BSR mode.
 - The BSR mode stops and the red light at the presser foot goes off.

- > Touch the icon BSR (1) to deactivate the BSR mode and to quilt without automatic stitch length.

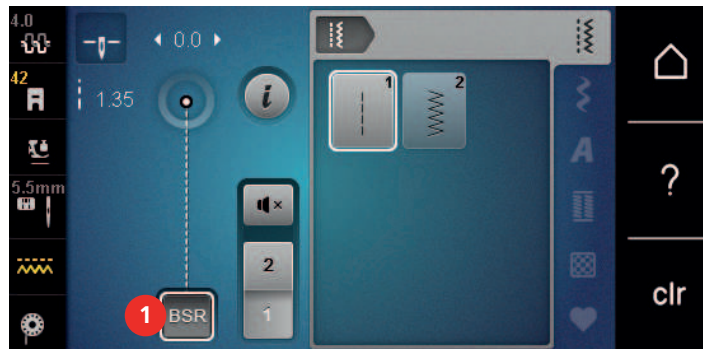

11.7 Securing

Securing in BSR1 mode with the button «Start/Stop»

Prerequisite:

- The BSR presser foot is attached and connected with the machine.
- The BSR display is opened and the BSR1 mode is activated.

- > Lower the feed dog.
- > Lower the presser foot.
- > Push the button «Needle up/down» twice.
 - The bobbin thread is brought up.
- > Hold the upper and the bobbin thread.



- > Push the button «Start/Stop».
 - Start the BSR mode.



- > Sew 5 – 6 securing stitches.
- > Push the button «Start/Stop».
 - The BSR mode stops.
- > Cut the thread.

12 Attachment

12.1 Maintenance and cleaning

Cleaning the display

- > Clean the display when it is switched off with a soft slightly damp microfiber cloth.

Cleaning the feed dog



Electronically driven components

Risk of injury near the needle and the hook.

- > Switch the machine off and disconnect it from the power supply system.

Remove the thread remnants under the stitch plate regularly.

- > Remove the presser foot and the needle.
- > Push the button «Feed dog up/down» to lower the feed dog.



- > Remove the stitch plate.
- > Clean the feed dog with the brush.

Cleaning the hook



Electronically driven components

Risk of injury near the needle and the hook.

- > Switch the machine off and disconnect it from the power supply system.

- > Open the bobbin cover.
- > Remove the bobbin case.
- > Push the fastening bracket to the left.

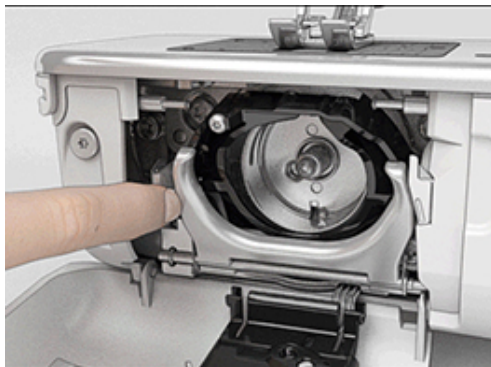

- > Flap down the fastening bracket along with the black hook race cover.

- > Remove the hook.

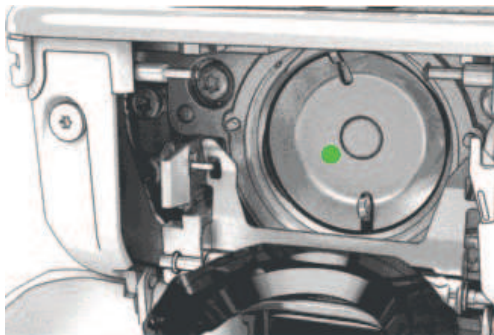

- > Clean the hook race with a brush; do not use any pointed objects.
- > Hold the hook at the pin in the center with two fingers.
- > Lead the hook, lower edge ahead, angular top-down behind the hook race cover.
- > Position the hook with the two lugs meeting the openings in the hook, the colored mark on the hook driver should be visible through the hole in the hook.
- > Insert the hook.
 - The hook is magnetic and therefore fastened to the correct position.
- > Close the hook race cover and the fastening bracket until the release bracket engages.
- > As a check, turn the handwheel.
- > Insert the bobbin case.

Lubricating the hook



CAUTION

Electronically driven components

Risk of injury near the needle and the hook.

- > Switch the machine off and disconnect it from the power supply system.

NOTICE

Lubricating the hook

Too much oil can pollute the fabric and the thread.

- > Always sew a test sample first.

- > Remove the bobbin case.
- > Press the release lever to the left.

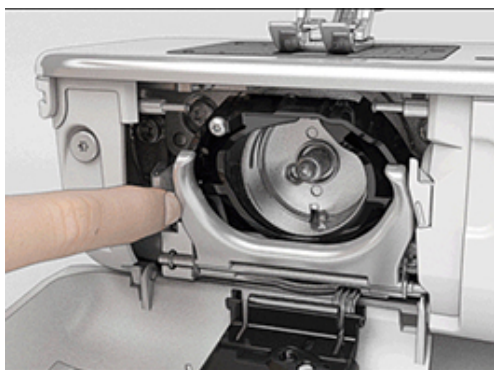

- > Flap down the fastening bracket with the black hook race cover.

- > Remove the hook.

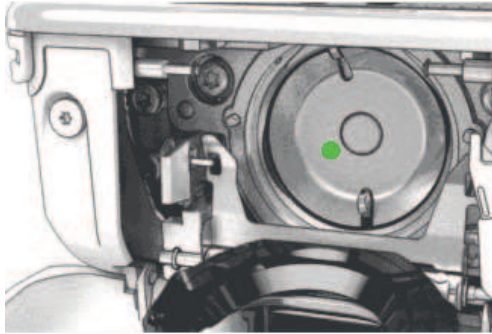

- > Give one drop of BERNINA oil down in the hook race.



- > Give one drop of oil in each of the two oil depots so that the felts are damp and make sure that the red-marked surface of the hook sleeve remains free of oil.







- > Hold the hook at the pin in the center with two fingers.
- > Lead the hook, lower edge ahead, angular top-down behind the hook race cover.
- > Position the hook with the two lugs meeting the openings in the hook, the colored mark on the hook driver should be visible through the hole in the hook.
- > Insert the hook.
 - The hook is magnetic and therefore fastened to the correct position.
- > Close the hook race cover and the fastening bracket until the release lever engages.
- > As a check, turn the handwheel.
- > Insert the bobbin case.

12.2 Troubleshooting

Fault	Cause	Repair
Uneven stitch formation	Upper thread too tight or too loose.	> Adjust the upper thread tension.
	Needle blunt or bent.	> Replace the needle, make sure that a new BERNINA quality needle is used.
	Poor quality needle.	> Use a new BERNINA quality needle.
	Poor quality thread.	> Use quality thread.
	Incorrect needle/thread combination.	> Match the needle with the thread size.
	Incorrectly threaded.	> Rethread.
	The fabric has been pulled.	> Feed the fabric evenly.
Uneven stitch formation	Incorrect bobbin case is used.	> Use the supplied bobbin case with triangles.
		
Skipped stitches	Incorrect needle.	> Use the needle system 130/705H.
	Needle blunt or bent.	> Replace the needle.
	Poor quality needle.	> Use a new BERNINA quality needle.
	The needle is incorrectly inserted.	> Insert the needle with the flat side to the back as far up as it will go into the needle holder and tighten the screw.
	Incorrect needle point.	> Match the needle point to the texture of the material.
Faulty stitching	Thread remnants between the thread tension discs.	> Fold a piece of thin material and slide the folded edge (not the raw edges) between the thread tension discs.
	Incorrectly threaded.	> Rethread.
	Thread remnants below the bobbin case spring.	> Remove the thread remnants under the spring.

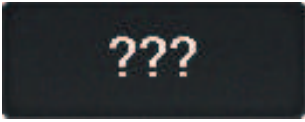
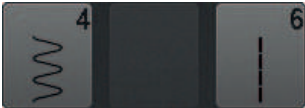
Fault	Cause	Repair
Speed too low	Unfavorable room temperature.	> Place the machine in a warm room one hour before use.
	Settings in the Setup Program.	> Adjust the sewing speed in the Setup Program. > Adjust the slide.
The machine doesn't start	Unfavorable room temperature.	> Place the machine in a warm room one hour before use. > Connect the machine and switch it on.
	The machine is damaged.	> Contact the specialized BERNINA dealer.
Error during software update	USB stick is not recognized.	> Use a BERNINA USB stick.
	The update process is blocked and the hourglass on the display is inactive.	> Remove the USB stick. > Switch the machine off. > Switch the machine on. > Follow the instruction on the display.
	Date of the software update cannot be found.	> Unzip the update data. > Save data of the software update directly on the data medium and not in a file on the USB stick.

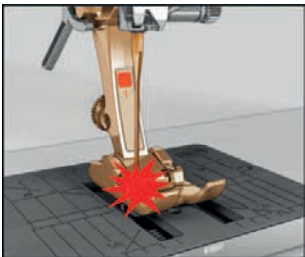
12.3 Error messages

Message on the display	Cause	Repair
	Stitch number unknown.	> Check the entry and enter the new number.
	Selection of the stitch pattern not possible in the combi mode.	> Combine other stitches.
	The feed dog is not lowered.	> Push the button Feed dog up/down to lower the feed dog.
	The selected needle and stitch plate cannot be used in combination.	> Replace the needle. > Replace the stitch plate.
	The needle is not at its top end.	> Adjust the needle position via the handwheel.
	The main motor isn't running.	> Turn the handwheel clockwise until the needle is at its top position. > Remove the stitch plate. > Remove the thread remnants. > Clean the hook. > Remove the hook and make sure that there are no pieces of broken needle points on the magnetic back of the hook.
Too less free capacity on the BERNINA USB stick (optional accessory).	Not enough free capacity on the BERNINA USB stick (optional accessory).	> Make sure that the BERNINA USB stick (optional accessory) is used. > Delete data from the BERNINA USB stick (optional accessory).
No personal data on the BERNINA USB stick (optional accessory).	No personal data for recovery available on the BERNINA USB stick (optional accessory).	> Make sure that the data and settings have been saved on the BERNINA USB stick (optional accessory).

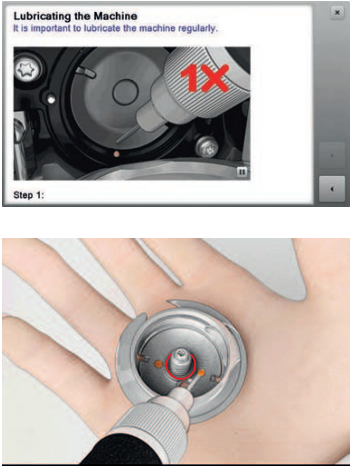
Message on the display	Cause	Repair
The recovery of personal data has failed.	The software update has been successful but the personal data couldn't be recovered.	<ul style="list-style-type: none"> > Make sure that the data and settings have been saved on the BERNINA USB stick (optional accessory). > Transfer saved data to the machine.
No BERNINA USB stick is inserted. Make sure that during the complete automatic update always the same BERNINA USB stick remains inserted.	The BERNINA USB stick (optional accessory) is not inserted.	<ul style="list-style-type: none"> > Use a BERNINA USB stick (optional accessory) providing enough free capacity.
The update of the software has failed.	The latest software version cannot be found on the USB stick.	<ul style="list-style-type: none"> > Make sure that the data for the software update has been unzipped. > Check whether the data for the software update are saved directly on the data medium and not in a file on the USB stick. > Update the software.
	The machine needs cleaning/lubricating.	<ul style="list-style-type: none"> > Clean the machine. > Lubricate the hook. <p>Important information on lubricating: Too much oil can pollute the fabric and the thread.</p> <ul style="list-style-type: none"> > After lubricating, embroider a test piece first.
The automatic thread cutter (at the thread catcher) needs cleaning.	The thread catcher needs cleaning. The message appears everytime when the machine is started as soon as 1000 cutting cycles have been carried out.	<ul style="list-style-type: none"> > Touch the icon «Confirm». <ul style="list-style-type: none"> – The machine calls up the function «Clean the thread catcher». > Clean the thread catcher according to the instructions on the display. <ul style="list-style-type: none"> – The counter for the cutting cycles is reset.

Message on the display	Cause	Repair
It is time for the regular maintenance. Please contact your specialized BERNINA dealer to make an appointment.	<p>The machine needs maintenance. The message appears after the programmed service interval has expired.</p> <p>Important information: Having your machine cleaned and serviced properly at the appropriate times ensures its proper functioning and a long service life. Ignoring the terms can affect the operating life and restrict the guaranteeing. The cost allocation for maintenance work is regulated nationally. Consult your specialized BERNINA dealer or servicing shop for more details.</p>	<ul style="list-style-type: none"> > Contact the specialized BERNINA dealer. > Delete the message temporarily by touching the icon «ESC». <p>Having cleared the message three times, the message will appear as recently as the next service interval has been completed.</p>

12.4 Storage and disposal

Storing the machine

It is recommended to store the machine in the original packaging. If the machine is stored in a cold room, place it in a warm room one hour before use.

- > Switch the machine off and disconnect it from the power supply system.
- > Don't store the machine outdoor.
- > Protect the machine against climatic influences.

Dispose of the machine

BERNINA International AG is committed to the protection of the environment. We strive to minimize the environmental impact of our products by continuously improving product design and our technology of manufacturing.

When the machine won't be used anymore, dispose this product in an environmentally responsible way according to the national directive. Do not throw away this product with your household waste. When in doubt, bring the machine to your local specialized BERNINA dealer.

- > Clean the machine.
- > Sort the components by their materials and dispose of them according to the local laws and regulations.











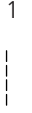
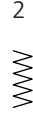
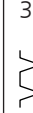
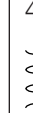









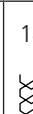



12.5 Technical data

Term	Value	Measurement unit
Maximum fabric thickness	10.5 (0,41)	mm (inch)
Sewing light	8	LED
Maximum speed	900	spm/rpm
Measurements without the spool pin	465/330/200 (18.30/12.99/7.87)	mm (inch)
Weight	10.0	kg
Energy consumption	90	Watt
Input voltage	100-240	Volt
Protection class (Electrical engineering)	II	
Production date: Can be seen on the type plate under «Code».		



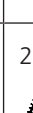
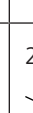









13 Overview stitch patterns

13.1 Overview Stitch patterns

Practical stitches













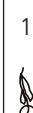
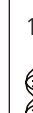









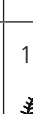
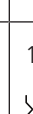

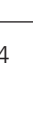
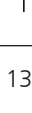
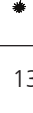
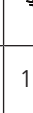

1 	2 	3 	4 	5 	6 	7 	8 	9 	10 	11 
12 	13 	14 	15 	16 	17 	18 	19 	20 	22 	23 
24 	25 	26 	29 	30 	32 	33 				

Buttonholes

51 	52 	53 	54 	55 	56 	57 	59 	63 	60 	61 
62 										

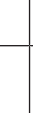
Decorative stitches

Natural stitches

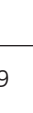
101 	102 	103 	104 	106 	107 	108 	109 	110 	111 	112 
113 	114 	115 	116 	117 	118 	119 	122 	123 	124 	125 
136 	137 	138 	139 	140 	150 	152 	167 	168 	169 	170 

Cross stitches

301	302	303	304	305	306	307	308	309	314	319
320	321	322	323	324	325	326	327	328		

Satin stitches













































401	402	405	406	407	408	409	410	412	413	414
415	416	417	422	423	424	425	426	427	428	429
431	434	437	440	442	443	457	461	465	466	

Ornamental stitches





































601	602	603	604	605	606	607	608	609	610	611
612	613	614	615	616	618	619	620	621	622	623
624	625	626	627	628	629	630	631	633	634	635
636	639	640	641	642	643	644	645	648	649	650
651	652	653	654	655	656	657	660	661	664	665

666										
										



























Heirloom stitches

701	702	703	704	705	706	707	708	709	710	711
										
712	713	714	715	716	717	721	722	723	724	725
										
726	727	729	730	731	732	738	739	741	742	743
										
748	749	750	751	752	755	756	762	764	765	767
										
768										
										

Children stitches

901	902	903	904	905	906	907	908	909	910	911
										
912	913	914	915	916	917	918	919	920	921	922
										
924	926	928	929	935	937	944	948	949	950	952
										
954	955	961								
										

Quilt stitches

1301 	1302 	1303 	1304 	1305 	1306 	1307 	1308 	1309 	1310 	1311 
1313 	1314 	1315 	1316 	1317 	1318 	1319 	1320 	1321 	1322 	1323 
1324 	1331 	1332 	1333 	1334 						

T

Technical data	126
Threading the bobbin thread	46
Threading the double needle	44
Threading the triple needle	45
Threading the upper thread	42
Troubleshooting	122

U

Updating the machine Firmware	58
Using a spool net	35
Using eco mode	61

W

Welcome to the world of BERNINA	15
---------------------------------	----

